

Williams[®]

16P-490-100
Game No. 490
March, 1979

STELLAR WARS

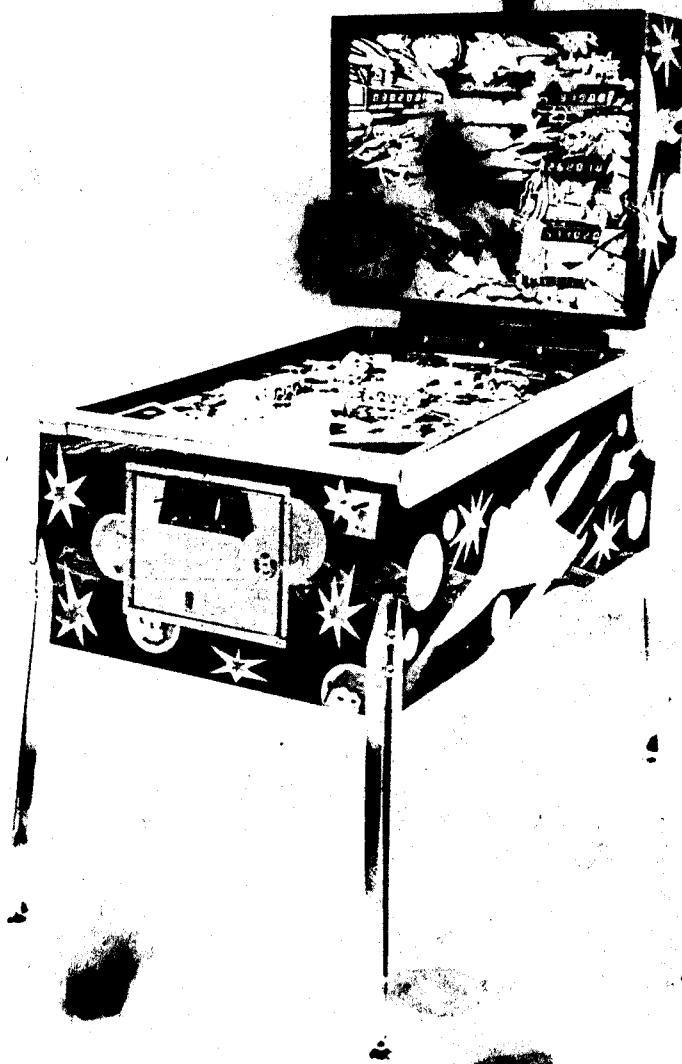

For service call TOLL-FREE:
800-621-4765
In Illinois call
800-972-7898



Williams[®]
ELECTRONICS, INC.

An Xcor International Inc. Company
3401 N. California Ave., Chicago, IL 60618
Cable Address: WILCOIN, CHICAGO
(312) 267-2240

CONTENTS

Section	Page
1. INSTALLATION	2
Assembly and Interconnection	2
Inspection	3
Power Turn-On	6
2. GAME OPERATION	6
3. GAME ADJUSTMENTS	7
General Procedure	7
High Score to Date	9
Replay Scores	9
Maximum Credits	9
Standard Game Pricing	10
Custom Game Pricing	10
Pricing Formula	11
Credits in Game	12
High Score Credits	12
Play	12
Match	13
Special	13
Scoring Awards	13
Number of Balls	14
Maximum Plumb Bob Tilts	14
Unique Game Adjustments	14
Restoring Factory Settings	15
4. GAME BOOKKEEPING AND EVALUATION ..	15
Feature Access	15
High Score Reset	16
Resetting Audit Totals	16
5. BUILT-IN DIAGNOSTICS	16
Display Digits Test	16
Lamp Test—Test 01	16
Solenoid Test—Test 02	18
Switch Test—Test 03	18
Auto Cycle Mode	18
6. MAINTENANCE	20
Board Replacement	20
CPU Board Self-Test	22
Sound Board Self-Test	22
Troubleshooting Charts	23
Lamps	23
Switches	23
Solenoids	24
Master Display	24
Player Display	24
Game Operation	25
Inoperative or Blows Fuses	25
Losing Memory	25
No Response to CPU Self-Test or Intermittent Operation	26
Sound Problems	26
7. INTERCONNECTION CHARTS	26
8. MECHANICAL ADJUSTMENTS	37
9. SPARE PARTS	37

SECTION 1 INSTALLATION

This section provides information for assembly and interconnection, inspection, and power turn-on for solid state pinballs.

ASSEMBLY AND INTERCONNECTION

To assemble and interconnect the game, proceed as follows:

1. Remove the two cartons and the cabinet from the shipping carton.
2. Carefully set the cabinet on end with the rear of the cabinet on the floor.
3. Open the stapled carton and remove the four legs and the cashbox.
4. Remove the ball, eight acorn bolts and four backbox mounting bolts from the cash box.
5. Mount the two front legs using four acorn bolts.
6. Carefully lower the cabinet so that it is supported on the front legs.
7. Take the backbox from its carton and remove the envelope containing the backbox keys from the top of it.
8. Center the backbox on the floor at the rear of the cabinet in an upright position oriented with the insert board parallel to the length of the cabinet.
9. Lift up the rear of the cabinet and carefully slide the backbox underneath it for support.
10. Mount the two rear legs using four acorn bolts.
11. Reach into the large hole at the rear of the cabinet, pull out the power cord, and place it in the slot provided.

NOTE

Do not plug the game in and do not pull up any other cables from the cabinet at this time.

12. The backbox has a metal bracket protruding from the bottom hole that will engage a similar bracket on the cabinet pedestal to prevent the backbox from tipping forward when the insert door is opened. Place the backbox onto the pedestal, engaging the bracket.
13. Remove the shipping blocks from the insert door.
14. Lift up on the latch at the right side of the insert door and open the door.
15. Secure the backbox to the cabinet using the four bolts and washers.

NOTE

Refer to Figure 1. There are seven cables (four from the playfield and three from the cabinet) that must be interconnected with cables from the backbox. The connectors are size and color coded except for the power switch to transformer connection, where the colors do not match.

16. Reach into the cabinet through the hole in the backbox and pull out all cables.
17. Interconnect the 24-pin black plug and connector (8P3/8J3) for the playfield solenoids.
18. Interconnect the 24-pin white plug and connector (8P2/8J2) for the playfield lamps.
19. Interconnect the 15-pin white plug and connector (8P1/8J1) for the playfield switches.
20. Interconnect the 3-pin white plug and connector (6P1/6J1) for the switched ac power to the transformer.
21. Interconnect the 1-pin white plug and connector (6P2/6J2) for the flipper solenoid B+.
22. Interconnect the 9-pin white plug and connector (6P3/6J3) for the sound board power.

23. Interconnect the 36-pin white plug and connector (7P1/7J1) for the cabinet solenoids and switches.
24. Pull the ground braid from the left side of the cabinet through the hole in the backbox and connect it under the wing nut and washer located on the backbox shield liner in front of the rectangular hole.
25. With the coin door keys (taped to the ball shooter handle) unlock the coin door.
26. Install the coin box.

INSPECTION

Inspection consists of checking that all cable connections are securely made, that all socketed integrated circuits (ICs) are firmly in their sockets, and a general visual inspection.

1. Check all connectors in the backbox to make sure that none of the wire terminations have come loose or were pushed out. Reseat any loose wires by pushing in on the wire termination.
2. Push on all connectors attached to the CPU Board (Figure 2—No. 1) to make sure they are firmly seated.
3. Push on all connectors attached to the Driver Board (Figure 2—No. 2) to make sure they are firmly seated.
4. Push on all connectors attached to the Power Supply Board (Figure 2—No. 3) to make sure they are firmly seated.
5. Check the connection on both bridge rectifiers (Figure 2—No. 5) and the filter capacitor (Figure 2—No. 6).
6. Push on all connectors attached to the Master Display

Board (Figure 2—No. 12) and the four individual player displays (Figure 2—Nos. 8, 9, 10, and 11).

7. Gently press on the socketed IC packages on the CPU Board (Figure 3). DO NOT remove any of the IC packages from their sockets.
8. Check that the batteries are still securely mounted on the CPU Board. DO NOT REMOVE THE BATTERIES! If the batteries are removed with power OFF, the game will go to factory settings for all the features and particular changes will have to be restored manually before the game can be put on location.

NOTE

The batteries are installed with the positive (+) end up. Battery life is about the same as shelf life or about one year. When it is time to replace the batteries, remove the batteries with the power ON or the game will revert to factory settings.

9. Check and push on the connectors which interconnect the coin door mechanism to the cabinet.
10. Remove the playfield glass and carefully set it aside.
11. Carefully raise the playfield and support it with the brace(s).
12. Push on all the connectors attached to the Sound Board (Figure 2—No. 20).
13. Gently press on the socketed IC packages on the Sound Board (Figure 4).
14. Check that all cables are clear of moving parts and for any wires that may have come disconnected from the playfield or cabinet.

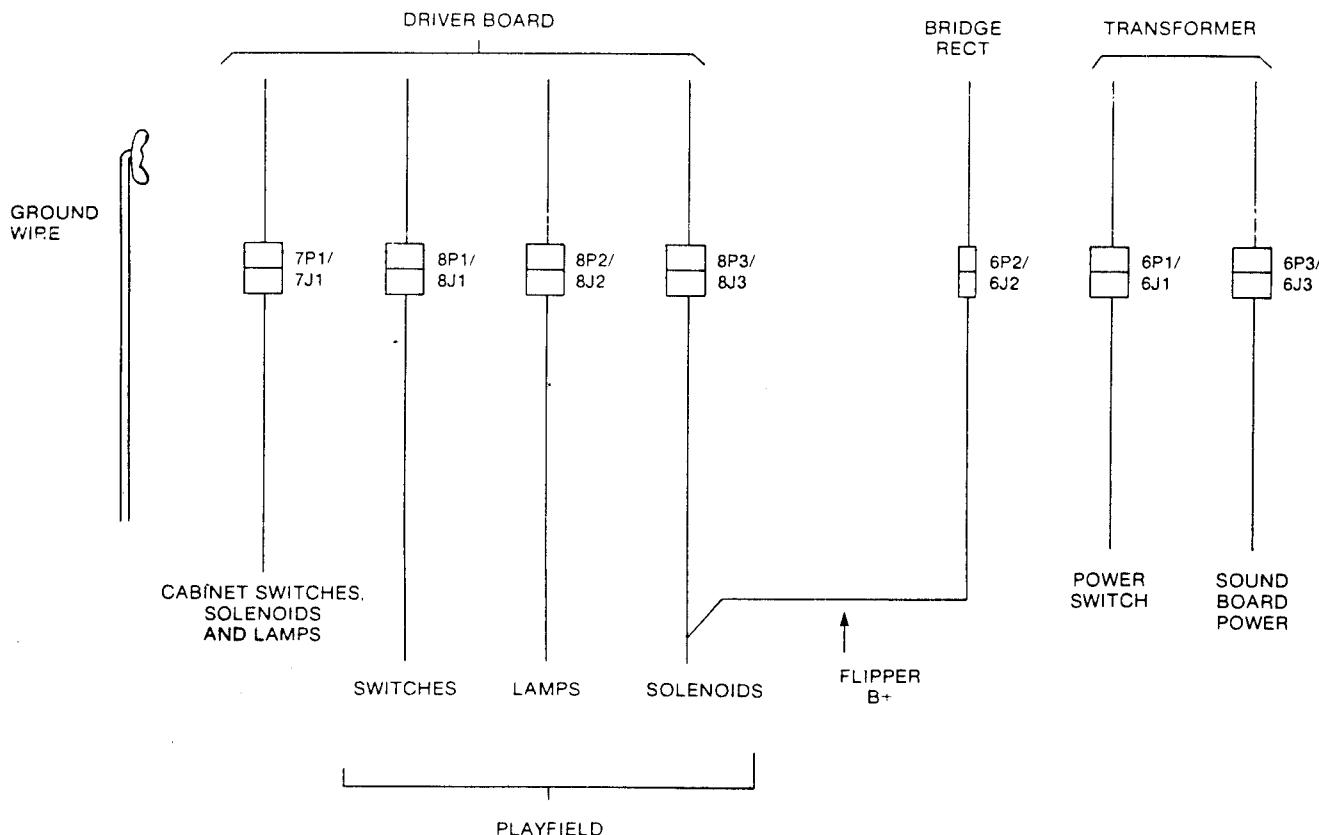

Figure 1. Backbox Interconnections

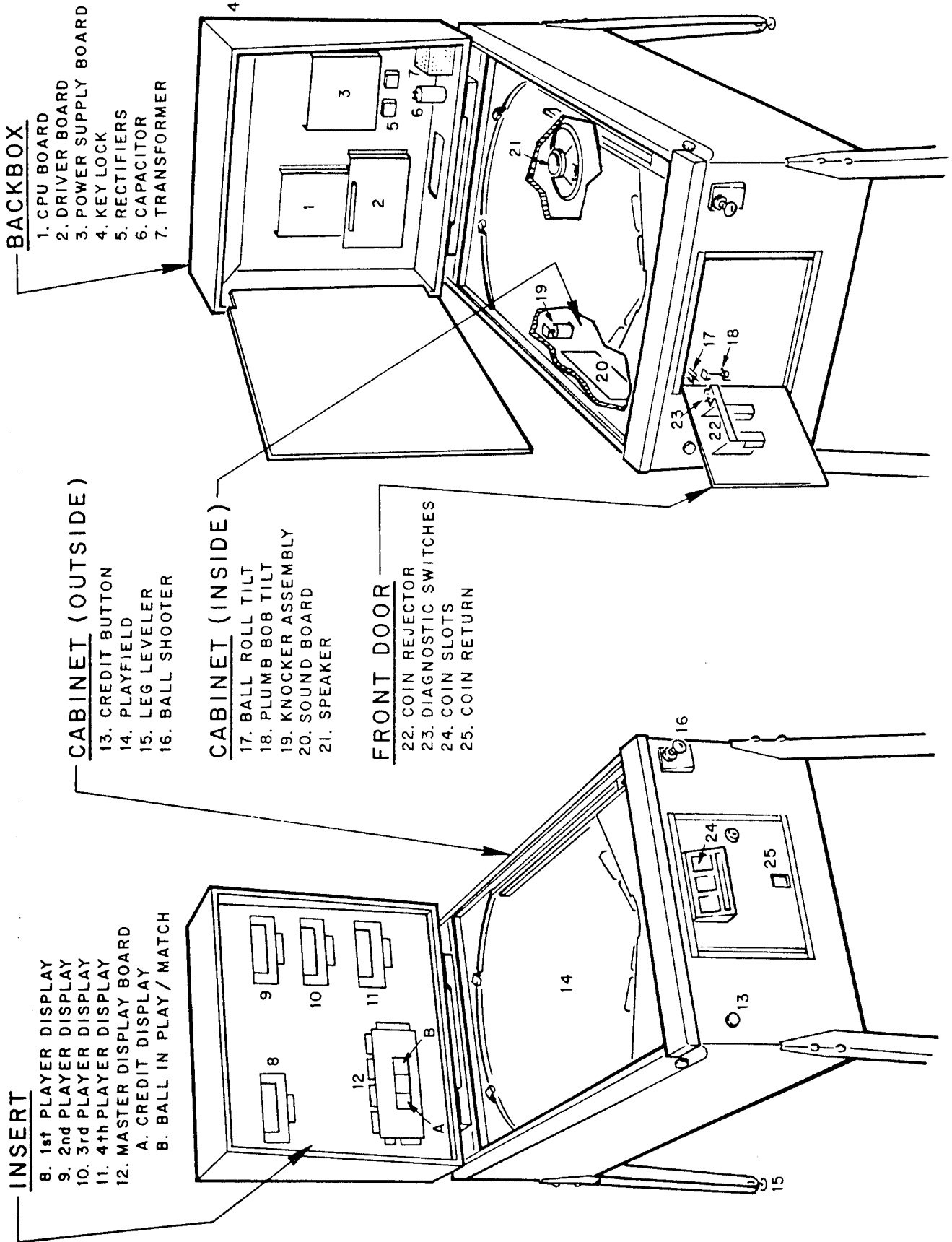

Figure 2. Location of Major Assemblies

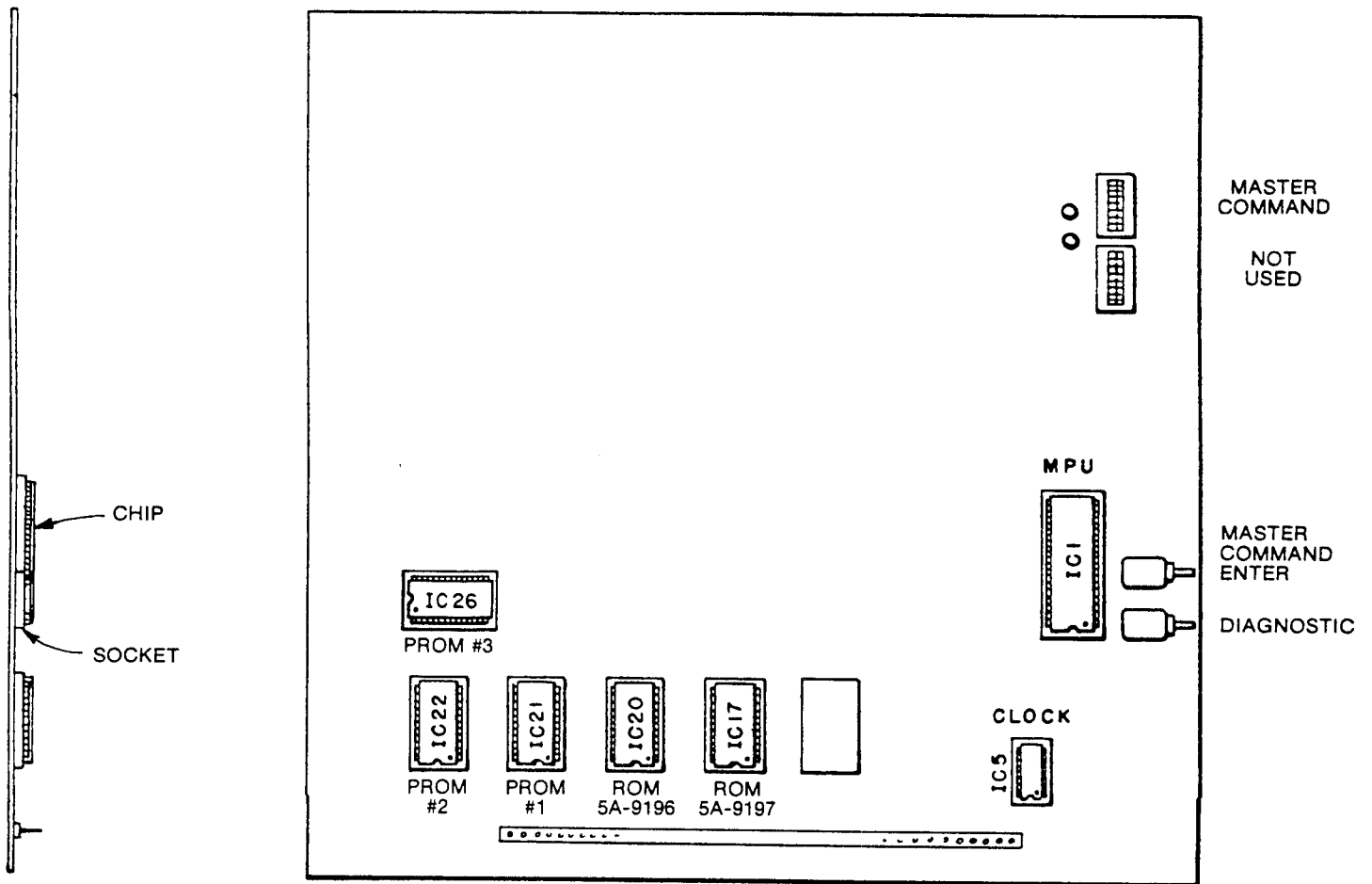

Figure 3. Location of Socketed Components and Switches on CPU Board

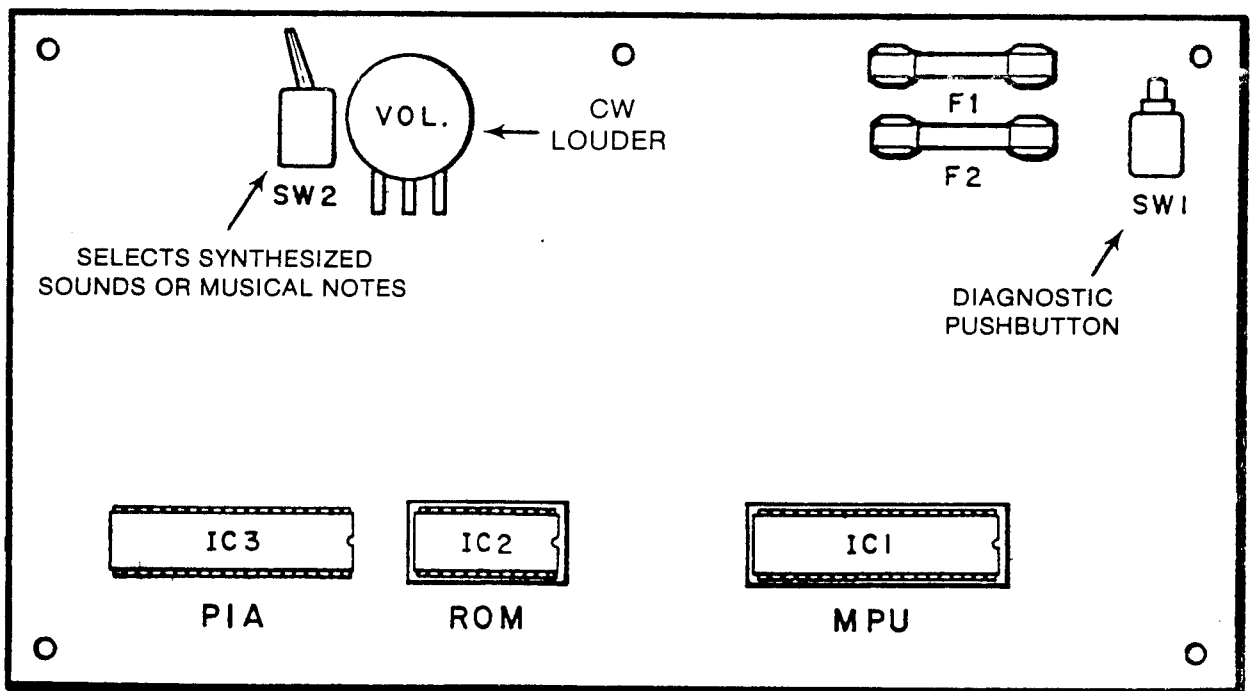

Figure 4. Location of Key Components on Sound Board

15. Check switches for loose solder or other foreign material that may have come loose during shipment.
16. Check wires on coils for proper soldering.
17. Check that the flipper B+ fuse on the playfield is secure and that the fuses on the sound board and the two fuses adjacent to it are secure.
18. Check adjustment of the tilt switches:
 - a. Playfield Shake on the bottom of the playfield.
 - b. Plumb Bob and Ball Roll tilts (Figure 2 Nos. 18 and 17).
 - c. Slam Tilt on the coin door.
19. Install the ball in the ball roll tilt if not already installed and insert the captive ball through the slot in the plastic in the lane for the upper left Bull's-Eye target.
20. Lower the playfield and check that the four fuses on the Power Supply Board are secure.
21. Check adjustments of the ball shooter guide using information provided in Section 8.

POWER TURN-ON

This machine **MUST BE PLUGGED INTO A PROPERLY GROUNDED OUTLET** to PREVENT SHOCK HAZARD and to insure PROPER GAME OPERATION. DO NOT use a "cheater plug" to defeat the ground pin on the power cord, and DO NOT cut off the ground pin. The line voltage MUST agree with that specified on the shipping carton or serious damage to the game will occur when it is plugged in. To apply power and check out the game, proceed as follows:

1. Plug the power cord into an outlet and turn on the power switch located near the right front cabinet leg. The game should come on in the game over mode as indicated by the player scores reading zero, player 1 up light flashing, game over lights lit, and the high score to date alternating with the player 1 score.
2. If the game comes on with the number of credits display (Figure 2—No. 12A) showing 04, the ball in play display (Figure 2—No. 12B) showing 00, and the player 1 display showing the PROM identification and revision number, turn the game OFF and then ON again. The game should now come up in the game over mode.

NOTE

Indications in step 2 are a result of the batteries being removed with the power OFF or coming loose during shipment. This has also resulted in features reverting to factory settings and any changes from the factory settings must be re-entered using procedures provided in Section 3 of this manual.

3. If the game does not come up in the game over mode after Steps 1 and 2, refer to troubleshooting in Section 6.
4. Perform diagnostic tests in accordance with procedures provided in Section 5 of this manual.
5. Make any desired changes to features in accordance with procedures provided in Section 3 of this manual.
6. Latch the insert door into position.
7. Release the backglass retainer bar with the backbox keylock, insert the backglass, and secure the backglass with the keylock.

8. Verify proper game operation using Section 2 as a guide.
9. Replace the playfield glass.

SECTION 2 GAME OPERATION

This Section provides an explanation of game operation.

Place the ball onto the playfield by the outhole. When the game is turned on it will come up in the game over mode. All player scores will be zero, high score to date* will alternate with the player 1 score, the player 1 up light will flash, and the game over lights will light.

When coins are inserted, credits will be posted. The knocker will sound for each credit. When the credit button on the front of the cabinet is pressed, the outhole kicker serves the ball, the credit display will be reduced by one, the ball in play will show 1, the startup tune will be played, and the player 1 up light will flash until the first switch or bumper is made. Pressing the credit button at any time before the ball in play display indicates 2 will allow additional players, change the number of player lights, and reduce the number of credits by one for each additional player.

The bonus is advanced by each wire form rolover, each drop target, the eject hole and the captive ball target. The bonus multiplier is advanced by spotting "1" through "4", spotting S-T-E-L-L-A-R, and spotting W-A-R-S. Spotting S-T-E-L-L-A-R and W-A-R-S scores 50,000.

The left 3-bank drop targets spots S-T as indicated by the arrows with general illumination bulbs. Making all targets on the left 3-bank the first time scores 5000 and lights the top jet bumpers. Making them a second time scores 10,000 and flashes the top jet bumpers. Each additional time they are made scores 5000. The top jet bumpers each score 100, 1000 when lit, and 2000 when flashing.

The 4-bank drop targets spots E-L-L-A as indicated by the arrows with general illumination bulbs. Making all targets in the 4-bank scores 5000 and advances lighting of the eject hole lamps for a possible Extra Ball and towards lighting the outlane rollovers for a possible special.

The center target in the right 3-bank of drop targets* spots "R". Making all targets in the right 3-bank the first time scores 5000; a second time scores 10,000, a third time scores 15,000, a fourth time scores 20,000 and fifth and succeeding times score 30,000. In addition, making all targets in this bank advances lighting of the captive ball, bottom jet bumpers, the spinners, and the lower right bull's-eye target Special. The captive ball target scores 5000 and when lit scores 10,000 and spots a letter in STELLAR WARS. The bottom jet bumpers and spinners score 100 and 1000 when lit. The lower right Bull's-Eye target scores 2000.

All standups and kickers score 10. All other scoring is as previously described or as indicated on the playfield. Partial spotting of "1" through "4" and bonus multipliers below 5X* are restored for subsequent balls. Lighting of eject hole lamps* are also restored for subsequent balls.

Extra ball* won during the course of the game is played immediately after the player's regular ball enters the outhole. After the last ball is played, the match digits* appear where the ball in play digits were. If match occurs an extra credit will be awarded,* the game over tune will play and the game over lights will light. The high score to date will alternate with the winning player's score.

If a player's score exceeds the current high score to date, three* credits will be awarded, the game will play a high

score to date tune, and the highest score to date lights will remain lit.

The Plumb Bob Tilt tilts the ball in play on the third* closure. The Ball Roll and Playfield Shake tilt switches tilt the ball in play immediately. The Slam tilt switch on the coin door sets all player scores to zero and returns the game to game over.

If coins are inserted or credits won and the maximum* number of credits is exceeded, the credits will be posted correctly but the coin lockout coil will be de-energized until the number of remaining credits is below the maximum. While the coil is de-energized, no credits may be won and any coins inserted will be rejected.

*These features are adjustable and the procedure is outlined in Section 3. In addition, there is no background sound when the Sound Board is set for musical notes.

SECTION 3 GAME ADJUSTMENTS

This section provides information for making game adjustments and reviewing game status. Williams now provides a greatly simplified method of customizing the game to the location or the operator's requirements. This section provides detailed procedures for making these changes.

There are four switches, all accessible from the coin door (Figure 5) or the front of the cabinet, which are used to display and change game features:

1. AUTO-UP/MANUAL-DOWN toggle switch (inside coin door)
2. ADVANCE pushbutton (inside coin door)
3. High Score Reset switch (inside coin door)
4. Credit Button—front of cabinet

GENERAL PROCEDURE

Game status functions are displayed and can be set in test 04. To enter test 04, the AUTO-UP/MANUAL-DOWN switch is set to AUTO-UP and the ADVANCE pushbutton is depressed in the **game over mode**. Test 04 will be entered with the number of credits display showing 04 and the ball in play display showing 00.

If problems are encountered making game adjustments (for example, the ADVANCE pushbutton does not function after entering test 04) refer to troubleshooting in Section 5.

Refer to Table 1. Functions 00 through 12 are system audit totals and cannot be changed from the coin door. Functions 13 through 35 can all be adjusted from the coin door.

In test 04, to advance from the system audit totals to game feature status display, the AUTO-UP/MANUAL-DOWN switch is first set to AUTO-UP. Each time the ADVANCE pushbutton is depressed, the display will advance to the next higher function number. Holding the ADVANCE pushbutton depressed causes the function numbers to advance rapidly. With the AUTO-UP/MANUAL-DOWN switch set to MANUAL-DOWN, depressing (or holding down) the ADVANCE pushbutton causes the function numbers to decrease (from 00 to 35 to 34, etc.).

With the desired function number showing in the ball in play display, the current setting is shown on the Player 1 display. With the AUTO-UP/MANUAL-DOWN switch in the AUTO-UP position, depressing the Credit Button advances the value of the current setting on the Player 1 display. Holding the credit button depressed causes the value to advance rapidly. With the AUTO-UP/MANUAL-DOWN switch set to MANUAL-DOWN, depressing (or holding in) the credit button causes the value to decrease. **The value left showing on the display is the new current setting.**

After all changes have been made and reviewed using test 04, the game is turned OFF and then back ON to return to the game over mode.

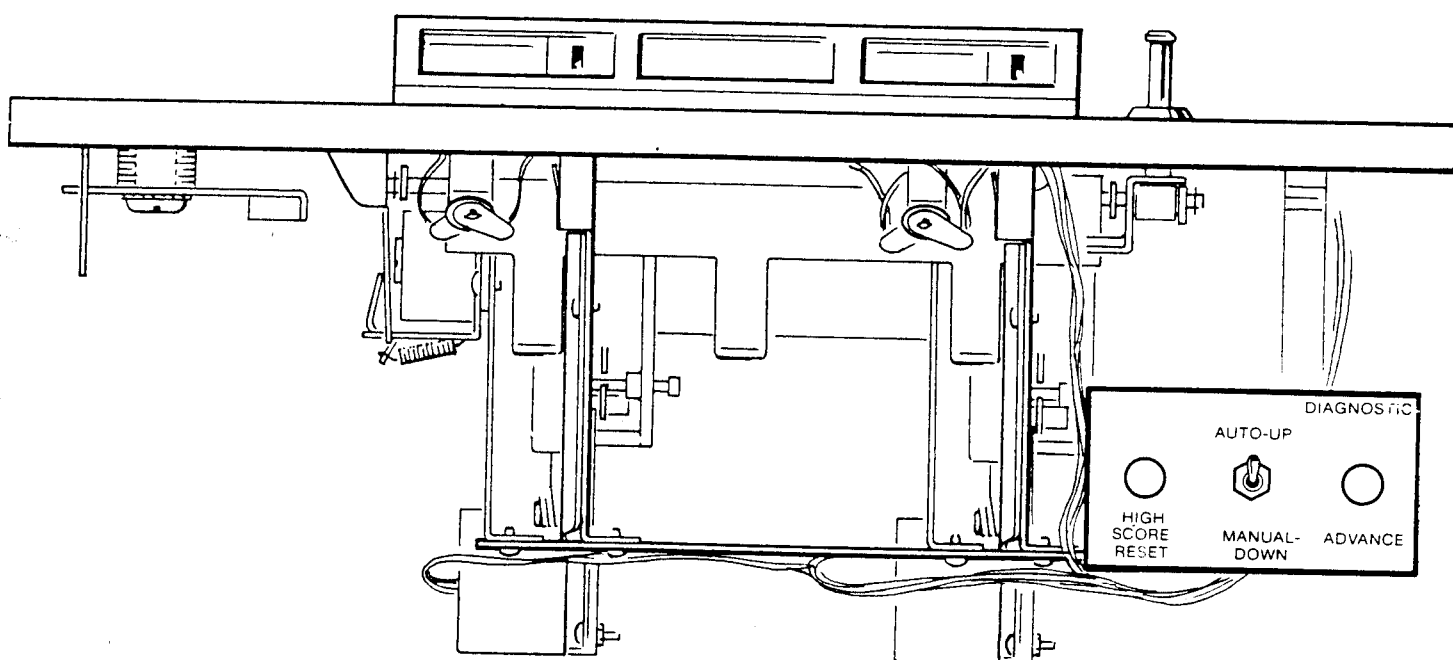

Figure 5. Coin Door Switches

Table 1. Game Adjustments

Function	Description	Notes	Factory Setting
00	PROM Identification	1	0490 1
01	Coins, Left Chute (Closest to coin door hinge)	1	—
02	Coins, Center Chute	—	—
03	Coins, Right Chute	—	—
04	Total Paid Credits	—	—
05	Total Specials	—	—
06	Total Replay (extra ball) scores	—	—
07	Match and High Score to Date credits	1,2	—
08	Total Credits	1,3	—
09	Total Extra Balls	—	—
10	Total ball time in minutes	—	—
11	Total number of balls played	—	—
12	Current High Score to Date	4	550,000
13	Backup High Score to Date	5	550,000
14	Replay 1 Score	5	250,000
15	Replay 2 Score	5	350,000
16	Replay 3 Score	5	450,000
17	Replay 4 Score (Disabled)	5	0
18	Maximum Credits	6	20
19	Standard and Custom Pricing Control (00-07)	7	02
20	Left Coin Slot Multiplier	7	01
21	Center Coin Slot Multiplier	7	01
22	Right Coin Slot Multiplier	7	01
23	Coin units required for credit	7	01
24	Coin units bonus point	7	00
25	Credits in game	—	00
26	High Score Credits	8	03
27	Play	—	04
	01-Eject Hole 2000 and 5000 lit separately, Captive Ball and Bottom Jet Bumpers lit together		
	02-Eject Hole 2000 and 5000 lit together, Captive Ball and Bottom Jet Bumpers lit together separately, Captive Ball and Bottom Jet Bumpers lit separately		
	03-Eject Hole 2000 and 5000 lit together, Captive Ball and Bottom Jet Bumpers lit together, Captive Ball and Bottom Jet Bumpers lit separately		
	04-Eject Hole 2000 and 5000 lit together, Captive Ball and Bottom Jet Bumpers lit separately		
28	Match (00=ON, 01=OFF)	—	00
29	Special	—	00
	00 = Awards Credit		
	01 = Awards Extra Ball		
	02 = Awards 50,000 Points		
30	Scoring Awards	—	
	00 = Credits at Replay Score		
	01 = Extra Ball at Replay Score		
31	Number of balls (03 or 05)	—	03
32	Maximum Plumb Bob Tilts (1-9)	—	03
33	Playfield Restore	9	00
	00-Bonus Multiplier and Eject Hole Lamps Restore		
	01-Eject Hole Lamps Restore		
	02-Bonus Multiplier Restores		
	03-Neither Feature Restores Extra Ball Control		
34	Extra Ball Control	—	00
	00 = Extra Ball allowed		
	01 = No Extra Ball		
35	Sweep Sound Select (00-31; 00=Sound Off)	10	00

Notes:

- Functions 00-11 cannot be changed from the coin door; however, Functions 01-11 can be set to zero as described in Section 4.
- Total credits (Function 08) is the sum of Function 04 and, as applicable, Functions 05, 06, and 07.
- Total extra balls (Function 09) is the sum of the game extra ball feature and Functions 05 and 06, as applicable.
- Current High Score to Date (Function 12) can be changed to the value of the backup High Score to Date (Function 13) by operating the HIGH SCORE RESET switch while in the game over mode.
- Functions 13-17 may be set to any multiple of 10,000 points. Setting a function to zero disables the High Score to Date (Function 13) or the replay score (Functions 14-17).
- Setting Maximum Credits (Function 18) to zero places the game in a free play mode.
- With Function 19 set to 00, Functions 20-24 can be set manually. Refer to Table 2 for seven standard pricing schemes (selected by values of 01-07 for Function 19) and custom pricing values.
- Setting Function 26 to zero with Function 13 set to any score but zero, permits the High Score to Date feature to operate but no credits are awarded.
- Bonus multiplier is not restored for any setting of Function 33 after "5X" is achieved.
- When sound for Function 35 is turned on, a setting of 30 is recommended.

RECOMMENDED SCORE LEVELS

Levels	Score Card
CREDIT GAMES	
3-Ball:	
*250,000; 350,000; 450,000	490-10
or 240,000; 390,000	490-30
5-Ball:	
420,000; 560,000	490-50
EXTRA BALL	
3-Ball:	
160,000	490-64
5-Ball:	
220,000	490-67
*Factory setting	

HIGH SCORE TO DATE

Depressing the High Score Reset switch in the game over mode changes the current high score to date (Function 12) to the value of the backup high score to date (Function 13).

The value of function 13 can be changed to any multiple of 10,000 points. With the value of function 13 set to zero, the high score to date feature is disabled. To change the backup high score to date, proceed as follows:

1. If not already in test 04, enter test 04 in one of the following ways:
 - a. From the game over mode, set the AUTO-UP/MANUAL-DOWN switch to AUTO-UP and depress the ADVANCE pushbutton.
 - b. From diagnostics, set the AUTO-UP/MANUAL-DOWN switch to AUTO-UP and depress the ADVANCE pushbutton to advance the diagnostics to test 04.
2. Set the AUTO-UP/MANUAL-DOWN switch to the desired position and operate the advance pushbutton until function 13 is indicated on the ball in play display. The backup high score to date is indicated in the Player 1 display.
3. To change the backup high score to date, proceed as follows:
 - a. To lower the backup value set the AUTO-UP/MANUAL-DOWN switch to MANUAL-DOWN.
To raise the backup value, set it to AUTO-UP.
 - b. Operate the credit button until the desired backup value is indicated on the player 1 display.

NOTE

To disable the high score to date feature, set function 13 to zero.

4. If no further game adjustments are required, turn the game OFF and back ON to return to the game over mode.

REPLAY SCORES

There are four possible replays awarded from scoring. The factory setting for the first three replay scores are provided in Table 1 and on the instruction booklet inside the game. The fourth replay is disabled. Replay 1 is function 14, replay 2 function 15, replay 3 function 16, and replay 4 function 17. Replay points can be increased or decreased by any multiple of 10,000 points. To make changes to replay points, proceed as follows:

1. If not already in test 04, enter test 04 in one of the following ways:
 - a. From the game over mode, set the AUTO-UP/MANUAL-DOWN switch to AUTO-UP and depress the ADVANCE pushbutton.
 - b. From diagnostics, set the AUTO-UP/MANUAL-DOWN switch to AUTO-UP and depress the ADVANCE pushbutton to advance the diagnostics to test 04.
2. Set the AUTO-UP/MANUAL-DOWN switch to the desired position and operate the ADVANCE pushbutton until function 14 is indicated on the ball in play display.
3. To change the score for Replay 1, proceed as follows:

- a. To raise the replay points, set the AUTO-UP/MANUAL-DOWN switch to AUTO-UP.
To lower the replay points, set it to MANUAL-DOWN.

- b. Operate the Credit button until the desired value is indicated on the Player 1 display.

NOTE

To disable any replay point, raise or lower the value in the Player 1 display to zero.

4. With the AUTO-UP/MANUAL-DOWN switch set to AUTO-UP, depress the ADVANCE pushbutton one time. Function 15 is indicated on the ball in play display and the current value of replay 2 is indicated on the Player 1 display.
5. To change the score for replay 2, perform steps 3a and 3b.
6. Repeat step 4 to display Function 16 on the ball in play display and the replay 3 score in the Player 1 display.
7. To change the score for replay 3, perform steps 3a and 3b.
8. Repeat step 4 to display Function 17 on the ball in play display and the replay 4 score on the Player 1 display.
9. To change the replay 4 score, perform steps 3a and 3b.
10. If no further game adjustments are required, turn the game OFF and back ON to return to the game over mode.

MAXIMUM CREDITS

Maximum credits is the number of credits that can be posted (by putting coins in the game or free credit awards) before the coin lockout relay is released. Maximum credits is Function 18 and the factory setting is 20. Maximum credits may be set to any value from 1 to 99; setting maximum credits to zero sets the game to a free play mode.

To make changes to maximum credits, proceed as follows:

1. If not already in test 04, enter test 04 in one of the following ways:
 - a. From the game over mode, set the AUTO-UP/MANUAL-DOWN switch to AUTO-UP and depress the ADVANCE pushbutton.
 - b. From diagnostics, set the AUTO-UP/MANUAL-DOWN switch to AUTO-UP and depress the ADVANCE pushbutton to advance the diagnostics to test 04.
2. Set the AUTO-UP/MANUAL-DOWN switch to the desired position and operate the ADVANCE pushbutton until Function 18 is indicated on the ball in play display.
3. To raise the maximum credits set the AUTO-UP/MANUAL-DOWN switch to AUTO-UP.
To lower the maximum credits set it to MANUAL-DOWN.
4. Operate the Credit button until the desired number of maximum credits is indicated on the Player 1 display.
5. If no further game adjustments are required, turn the game OFF and back ON to return to the game over mode.

STANDARD GAME PRICING

This feature accounts for differences in coin door mechanisms and how credits are awarded. Function 19 can be set to select one of seven standard game pricing schemes with fixed values for Functions 20 through 24. (Function 19 can also be set to allow custom pricing schemes where Functions 20 through 24 are set with appropriate values as described in the CUSTOM GAME PRICING paragraphs).

To select one of the standard pricing schemes, proceed as follows:

5. Operate the Credit button until the value determined in step 3 is shown in the Player 1 display.
6. **If no further game adjustments are required**, turn the game OFF and back ON to return to the game over mode.

CUSTOM GAME PRICING

With Function 19 set to zero, the five Functions 20 through 24 may be set manually for custom game pricing requirements. Functions 20, 21, and 22 relate to the type of coin door mechanism and Functions 23 and 24 relate to how credits are awarded. A large number of custom game pricing schemes are provided in Table 2 and are set in light type. If the required pricing scheme is not provided in Table 2, refer to the explanation that follows the procedure to determine the values for Functions 20 through 24. Proceed as follows:

1. If not already in test 04, enter test 04 in one of the following ways:
 - a. From the game over mode, set the AUTO-UP/MANUAL-DOWN switch to AUTO-UP and depress the ADVANCE pushbutton.
 - b. From diagnostics, set the AUTO-UP/MANUAL-DOWN switch to AUTO-UP and depress the ADVANCE pushbutton to advance the diagnostics to test 04.
2. Set the AUTO-UP/MANUAL-DOWN switch to the desired position and operate the ADVANCE pushbutton until Function 19 is indicated on the ball in play display.
3. Refer to Table 2 and determine the value of Function 19 required for the desired pricing scheme. (Standard pricing is set in **bold type**).
4. **To raise** the value of Function 19 set the AUTO-UP/MANUAL-DOWN switch to AUTO-UP. **To lower**, set it to MANUAL-DOWN.

1. If not already in test 04, enter test 04 in one of the following ways:
 - a. From the game over mode, set the AUTO-UP/MANUAL-DOWN switch to AUTO-UP and depress the ADVANCE pushbutton.
 - b. From diagnostics, set the AUTO-UP/MANUAL-DOWN switch to AUTO-UP and depress the ADVANCE pushbutton to advance the diagnostics to test 04.
2. Set the AUTO-UP/MANUAL-DOWN switch to the desired position and operate the ADVANCE pushbutton until Function 19 is indicated on the number of credits display.

Table 2. Standard and Custom Pricing Settings

COIN DOOR MECHANISM	CREDITS	FUNCTION					
		19*	20	21	22	23	24
Quarter, Twin-Quarter, or 3-Quarter	1/25c, 3/50c	01	01	01	01	01	02
	1/25c	02	01	01	01	01	00
	2/25c, 5/50c	00	02	02	02	01	04
	2/25c	00	02	02	02	01	00
	1, 50c	00	01	01	01	02	00
	1/50c, 3/\$1	00	01	01	01	02	04
	1/75c	00	01	01	01	03	00
Nickel-Dime-Quarter	1/25c, 3/50c	00	01	02	05	05	10
	1/25c	00	01	02	05	05	00
	2/25c	00	01	02	05	05	05
	1/15c, 2/25c	00	02	04	10	05	00
	1/10c, 3/25c	00	03	06	15	05	00
1DM, 5DM, 2DM	2/1DM, 5/2DM, 14/5DM	03	13	65	26	05	65
20-Cent, 50-Cent	1/20c, 3/50c	00	06	00	15	05	00
1 Franc, 5 Franc	1/1F, 6/5F	04	01	00	05	01	05
	1/1F, 7/5F	05	06	00	30	05	30
25 Cent, 1 Guilder	1/25c	06	01	00	04	01	00
	1/25c, 5/1G	00	01	00	04	01	04
50 Yen, 100 Yen	1/50Y, 2/100Y	07	01	00	02	01	00
1 Franc or	1/1F, 3/2F	01	01	01	01	01	02
1 Franc, 1 Franc	1/1F	02	01	01	01	01	00
5 Franc, 10 Franc	1/5F, 2/10F	07	01	00	02	01	00
	1/10F	00	01	00	02	02	00
2 Franc, 2 Franc	1/2F	02	01	01	01	01	00
10 Franc, 20 Franc	1/10F, 2/20F	07	01	00	02	01	00
1 Sucre, 1 Sucre	1/3S, 2/5S	00	02	00	02	05	00

*Function 19 set to values 01-07 automatically selects corresponding values of Functions 20-24. With Function 19 set to 00, Functions 20-24 must be set manually.

3. Set the AUTO-UP/MANUAL-DOWN switch to MANUAL-DOWN and operate the Credit button until 00 is indicated for Function 19 on the Player 1 display. With Function 19 set to 00, Functions 20 through 24 are set to zero and now can be changed as required.
4. Refer to Table 2 or use the explanation following this procedure and determine the required values for Functions 20 through 24.
5. Set the AUTO-UP/MANUAL-DOWN switch to AUTO-UP and momentarily depress the ADVANCE pushbutton. Function 20 should be indicated on the ball in play display.
6. For single chute coin doors, omit this step and leave the value of 00. For twin or 3-chute coin doors, operate the Credit button until the value for Function 20 determined in step 4 is indicated in the Player 1 display.
7. Momentarily depress the ADVANCE pushbutton. Function 21 should be indicated on the ball in play display.
8. For twin chute coin doors, omit this step and leave the value of 00. For single and 3 chute coin doors, operate the Credit button until the value for Function 21 determined in step 4 is indicated on the Player 1 display.
9. Momentarily depress the ADVANCE pushbutton. Function 22 should be indicated on the ball in play display.
10. For single chute coin doors omit this step and leave the value of 00. For twin or 3-chute coin doors, operate the Credit button until the value for Function 22 determined in step 4 is indicated on the Player 1 display.
11. Momentarily depress the ADVANCE pushbutton. Function 23 should be indicated on the ball in play display.
12. Operate the credit button until the value for Function 23 determined in step 4 is indicated in the Player 1 display.
13. Momentarily depress the ADVANCE pushbutton. Function 24 should be indicated on the ball in play display.
14. Omit this step if no bonus credits are to be awarded for inserting a certain value of coins. To award bonus credits, operate the Credit button until the value for Function 24 determined in step 4 is indicated on the Player 1 display.
15. If no other game adjustments are to be made, turn the game OFF and back ON to return to the game over mode.

PRICING FORMULAS

There are five different functions used to set custom game pricing. Three pertain to the coin door mechanism and the other two determine how credits are awarded. Since there are many combinations of coin values and coin mechanisms, this explanation details how the functions relate to each other and provides a generalized procedure for defining the desired pricing scheme.

Proportional values are assigned to Functions 20, 21, and 22 for the left (closest to hinge on coin door), center, and right coin chute, respectively.

Function 23 defines the value of coins required for a single credit in relation to the proportional values assigned to functions 20, 21, and 22. Function 24 permits awarding a

bonus credit for depositing some value of coin(s). A general procedure follows:

1. Determine the ratio of the coin chute values by dividing by the largest number that leaves a remainder of zero.

Examples:

$$25c \ 25c \ 25c; \div 25 = 1:1:1$$

$$1DM \ 5DM \ 2DM; \div 1 = 1:5:2$$

$$25c \ - \ 1G; \div 4 = 1:0:4$$

$$5c \ 10c \ 25c; \div 5 = 1:2:5$$

2. Determining the values of Functions 20 through 24 is done in one of two ways. The first method requires that bonus credit Function 24 be set to zero. The second method defines the Function 24 value. Since some pricing schemes may be implemented with either method, some with only the first method, and others with only the second method, both methods will have to be tried in some cases.

Both methods use the ratio calculated in step 1, the largest number of credits defined in the pricing scheme, and the number of smallest value coins required to obtain the largest number of credits.

Method 1

$$\text{Function 20} = Cd \times L$$

$$\text{Function 21} = Cd \times C$$

$$\text{Function 22} = Cd \times R$$

$$\text{Function 23} = Cn \times Lr$$

$$\text{Function 24} = 00$$

Method 2

$$\text{Function 20} = (Cd-1) \times L$$

$$\text{Function 21} = (Cd-1) \times C$$

$$\text{Function 22} = (Cd-1) \times R$$

$$\text{Function 23} = Cn \times Lr$$

$$\text{Function 24} = Cn \times (Cd-1)$$

Where:

Cd = the largest number of credits in scheme

Cn = the number of smallest value coins required for Cd

L = Left chute ratio number

C = Center chute ratio number

R = Right chute ratio number

Lr = Lowest coin chute ratio

Examples:

25c - 25c Coin door

1 Play/25c, 3 Plays/50c

Ratio = 1:0:1

$$L = 1$$

$$C = 0$$

$$R = 1$$

$$Lr = 1$$

In this example either method will produce proper values for functions 20-24.

Method 1

$$Cd = 3$$

$$Cn = 2 \text{ (two 25c coins for 3 plays)}$$

$$\text{Function 20} = Cd \times L = 3 \times 1 = 03$$

$$\text{Function 21} = Cd \times C = 3 \times 0 = 00$$

$$\text{Function 22} = Cd \times R = 3 \times 1 = 03$$

$$\text{Function 23} = Cn \times Lr = 2 \times 1 = 02$$

$$\text{Function 24} = 00$$

Method 2

$$Cd = 3$$

$$Cn = 2$$

$$\begin{aligned}\text{Function 20} &= (\text{Cd}-1) \times \text{L} = (3-1) \times 1 = 02 \\ \text{Function 21} &= (\text{Cd}-1) \times \text{C} = 00 \\ \text{Function 22} &= (\text{Cd}-1) \times \text{R} = 02 \\ \text{Function 23} &= \text{Cn} \times \text{Lr} = 2 \times 1 = 02 \\ \text{Function 24} &= \text{Cn} \times (\text{Cd}-1) = 2 \times (3-1) = 2 \times 2 = 04\end{aligned}$$

5c 10c 25c Coin door
1 Play/15c, 2 Plays/25c
 Ratio = 1:2:5

$$\begin{aligned}\text{L} &= 1 \\ \text{C} &= 2 \\ \text{R} &= 5 \\ \text{Lr} &= 1\end{aligned}$$

In this example, method 1 provides proper values but method 2 will not:

Method 1

$$\begin{aligned}\text{Cd} &= 2 \\ \text{Cn} &= 5 \text{ (five 5c coins required for 2 plays)}\end{aligned}$$

$$\begin{aligned}\text{Function 20} &= \text{Cd} \times \text{L} = 2 \times 1 = 02 \\ \text{Function 21} &= \text{Cd} \times \text{C} = 2 \times 2 = 04 \\ \text{Function 22} &= \text{Cd} \times \text{R} = 2 \times 5 = 10 \\ \text{Function 23} &= \text{Cn} \times \text{Lr} = 5 \times 1 = 05 \\ \text{Function 24} &= 00\end{aligned}$$

Method 2

$$\begin{aligned}\text{Cd} &= 2 \\ \text{Cn} &= 5\end{aligned}$$

$$\begin{aligned}\text{Function 20} &= (\text{Cd}-1) \times \text{L} = (2-1) \times 1 = 01 \\ \text{Function 21} &= (\text{Cd}-1) \times \text{C} = (2-1) \times 2 = 02 \\ \text{Function 22} &= (\text{Cd}-1) \times \text{R} = (2-1) \times 5 = 05 \\ \text{Function 23} &= \text{Cn} \times \text{Lr} = 5 \times 1 = 05 \\ \text{Function 24} &= \text{Cn} \times (\text{Cd}-1) = 5 \times (2-1) = 05\end{aligned}$$

By studying the values obtained in method 2 it will be determined that the values set up pricing for 2 plays for 25c (no plays for 15c). This example shows that some pricing schemes can be set up using only one of the methods.

20c - 50c Coin door
1 Play/20c, 3 Plays/50c
 Ratio = 2:0:5

$$\begin{aligned}\text{L} &= 2 \\ \text{C} &= 0 \\ \text{R} &= 5 \\ \text{Lr} &= 2\end{aligned}$$

In this example, only method 1 will produce proper values.

Method 1

$$\begin{aligned}\text{Cd} &= 3 \\ \text{Cn} &= 2.5 \text{ (two and one-half 20c coin required for 3 plays)}\end{aligned}$$

$$\begin{aligned}\text{Function 20} &= \text{Cd} \times \text{L} = 3 \times 2 = 06 \\ \text{Function 21} &= \text{Cd} \times \text{C} = 3 \times 0 = 00 \\ \text{Function 22} &= \text{Cd} \times \text{R} = 3 \times 5 = 15 \\ \text{Function 23} &= \text{Cn} \times \text{Lr} = 2.5 \times 2 = 05 \\ \text{Function 24} &= 00\end{aligned}$$

CREDITS IN GAME

The number of credits in the game can be set to any number from zero to 99 using Function 25. This allows for credits to be entered into the game or credits to be removed. To add or remove credits, proceed as follows:

1. If not already in test 04, enter test 04 in one of the following ways:
 - a. From the game over mode, set the AUTO-UP/MANUAL-DOWN switch to AUTO-UP and depress the ADVANCE pushbutton.

- b. From diagnostics, set the AUTO-UP/MANUAL-DOWN switch to AUTO-UP and depress the ADVANCE pushbutton to advance the diagnostics to test 04.

2. Set the AUTO-UP/MANUAL-DOWN switch to the desired position and operate the ADVANCE pushbutton until Function 25 is indicated on the ball in play display.
3. **To add credits**, set the AUTO-UP/MANUAL-DOWN switch to AUTO-UP.
To remove credits, set it to MANUAL-DOWN.
4. Operate the credit button until the desired number of credits is indicated in the player 1 display.
5. **If no further game adjustments are to be made**, turn the game OFF and back ON to return to the game over mode.

HIGH SCORE CREDITS

Function 26 determines the number of credits to be awarded when the current highest score is exceeded by a player. Note that the backup high score to date (Function 13) must be set to some value other than zero for the high score feature to operate. With Function 26 set to zero and Function 13 set to any value other than zero, the high score to date feature will still function but no credits will be awarded. To change the number of credits for exceeding the high score, proceed as follows:

1. If not already in test 04, enter test 04 in one of the following ways:
 - a. From the game over mode, set the AUTO-UP/MANUAL-DOWN switch to AUTO-UP and depress the ADVANCE pushbutton.
 - b. From diagnostics, set the AUTO-UP/MANUAL-DOWN switch to AUTO-UP and depress the ADVANCE pushbutton to advance the diagnostics to test 04.
2. Set the AUTO-UP/MANUAL-DOWN switch to the desired position and operate the ADVANCE pushbutton until Function 26 is indicated on the ball in play display.
3. **To increase** the number of credits, set the AUTO-UP/MANUAL-DOWN switch to AUTO-UP.
To decrease the number of credits, set it to MANUAL-DOWN.
4. Operate the credit button until the desired number of high score credits is indicated on the player 1 display.
5. **If no further game adjustments are required**, turn the game OFF and back ON to return to the game over mode.

PLAY

Function 27 controls game features for dropping all targets in the 4-bank and for dropping all targets in the right 3-bank. The 4-bank of drop targets advances lighting of the eject hole lamps towards a possible Extra Ball and towards lighting the outlane rollovers for a possible Special. The right 3-bank advances lighting of the captive ball, bottom jet bumpers, spinners, and, for a possible Special, the right Bull's-Eye target.

With Function 27 set to 01 the eject hole 2000 and 5000 lamps are lit separately and the captive ball and bottom jet bumpers are lit together. With it set to 02 the eject hole 2000 and 5000 lamps are lit together and the captive ball and bottom jet bumpers are again lit together. With it set to 03 both the eject hole 2000 and 5000 lamps and the captive ball and bottom jet bumper features are lit separately. With it set to 04 (factory setting), the eject hole 2000 and 5000 lamps are lit together and the captive ball and bottom jet bumpers are lit separately.

Note that to **disable the Extra Ball feature** and to prevent the eject hole Extra Ball when Lit lamp from being turned on, Function 34 (Extra Ball Control) must be changed. Refer to Unique Game Adjustments to disable the Extra Ball feature.

To adjust the play features, proceed as follows:

1. If not already in test 04, enter test 04 in one of the following ways:
 - a. From the game over mode, set the AUTO-UP/MANUAL-DOWN switch to AUTO-UP and depress the ADVANCE pushbutton.
 - b. From diagnostics, set the AUTO-UP/MANUAL-DOWN switch to AUTO-UP and depress the ADVANCE pushbutton to advance the diagnostics to test 04.
2. Set the AUTO-UP/MANUAL-DOWN switch to the desired position and operate the advance pushbutton until function 27 is indicated on the ball in play display.
3. **To raise** the value in the player 1 display set the AUTO-UP/MANUAL-DOWN switch to AUTO-UP.
To lower the value, set it to MANUAL-DOWN.
4. Operate the Credit button until the desired value is indicated on the player 2 display.
 - 01- Eject Hole 2000 and 5000 lit separately, Captive Ball and Bottom Jet Bumpers lit together
 - 02- Eject Hole 2000 and 5000 lit together, Captive Ball and Bottom Jet Bumpers lit together
 - 03- Eject Hole 2000 and 5000 lit separately, Captive Ball and Bottom Jet Bumpers lit separately
 - 04- Eject Hole 2000 and 5000 lit together, Captive Ball and Bottom Jet Bumpers lit separately
5. **If no further game adjustments are required**, turn the game OFF and back ON to return to the game over mode.

MATCH

Function 28 controls the match features. If this function is set to 00, the match feature is on. If it is set to 01, the feature is off. With the match feature on, a free credit is awarded at game over when the last two digits of a players score match the digits shown in the ball in play display.

To change the match feature, proceed as follows:

1. If not already in test 04, enter test 04 in one of the following ways:
 - a. From the game over mode, set the AUTO-UP/MANUAL-DOWN switch to AUTO-UP and depress the ADVANCE pushbutton.
 - b. From diagnostics, set the AUTO-UP/MANUAL-DOWN switch to AUTO-UP and depress the ADVANCE pushbutton to advance the diagnostics to test 04.

2. Set the AUTO-UP/MANUAL-DOWN switch to the desired position and operate the ADVANCE pushbutton until Function 28 is indicated on the ball in play display.
3. **To raise** the value of Function 28, set the AUTO-UP/MANUAL-DOWN switch to AUTO-UP.
To lower the value, set it to MANUAL-DOWN.
4. Operate the credit button until the desired value is indicated on the player 1 display (00 for match on or 01 for match off).
5. **If no further adjustments are required**, turn the game OFF and back ON to return to the game over mode.

SPECIAL

Function 29 controls the special feature. If this function is set to 00, a special awards a free credit; with the feature set to 01 or 02, a special awards an extra ball or bonus points, respectively. To change the award for a special, proceed as follows:

1. If not already in test 04, enter test 04 in one of the following ways:
 - a. From the game over mode, set the AUTO-UP/MANUAL-DOWN switch to AUTO-UP and depress the ADVANCE pushbutton.
 - b. From diagnostics, set the AUTO-UP/MANUAL-DOWN switch to AUTO-UP and depress the ADVANCE pushbutton to advance the diagnostics to test 04.
2. Set the AUTO-UP/MANUAL-DOWN switch to the desired position and operate the ADVANCE pushbutton until Function 29 is indicated on the ball in play display.
3. **To raise** the value of Function 29, set the AUTO-UP/MANUAL-DOWN switch to AUTO-UP.
To lower the value, set it to MANUAL-DOWN.
4. Operate the Credit button until the desired value is indicated in the player 1 display:
 - 00 - Special Awards Credit
 - 01 - Special Awards Extra Ball
 - 02 - Special Awards Points
5. **If no other game adjustments are required**, turn the game OFF and back ON to return to the game over mode.

SCORING AWARDS

Function 30 controls whether exceeding replay points awards a free credit or an extra ball. Setting the function to 00 awards a credit; setting it to 01 awards an extra ball. To adjust scoring, proceed as follows:

1. If not already in test 04, enter test 04 in one of the following ways:
 - a. From the game over mode, set the AUTO-UP/MANUAL-DOWN switch to AUTO-UP and depress the ADVANCE pushbutton.

- b. From diagnostics, set the AUTO-UP/MANUAL-DOWN switch to AUTO-UP and depress the ADVANCE pushbutton to advance the diagnostics to test 04.
2. Set the AUTO-UP/MANUAL-DOWN switch to the desired position and operate the ADVANCE pushbutton until Function 30 is indicated on the ball in play display.
3. **To raise** the value of Function 30, set the AUTO-UP/MANUAL-DOWN switch to AUTO-UP.
To lower the value, set it to MANUAL-DOWN.
4. Momentarily depress the Credit button so that the desired value is indicated on the player 1 display (00 for credit, 01 for extra ball).
5. **If no further adjustments are required**, turn the game OFF and back ON to return to the game over mode.

NUMBER OF BALLS

Function 31 controls the number of regular balls. To adjust Function 31 proceed as follows:

1. If not already in test 04, enter test 04 in one of the following ways:
 - a. From the game over mode, set the AUTO-UP/MANUAL-DOWN switch to AUTO-UP and depress the ADVANCE pushbutton.
 - b. From diagnostics, set the AUTO-UP/MANUAL-DOWN switch to AUTO-UP and depress the ADVANCE pushbutton to advance the diagnostics to test 04.
2. Set the AUTO-UP/MANUAL-DOWN switch to the desired position and operate the ADVANCE pushbutton until Function 31 is indicated on the ball in play display.
3. **To increase** the number of regular balls per game, set the AUTO-UP/MANUAL-DOWN switch to AUTO-UP.
To decrease the number, set it to MANUAL-DOWN.
4. Operate the credit button until the desired number of balls is indicated in the player 1 display.
 - 03 - 3 Ball Play
 - 05 - 5 Ball Play
5. **If no further game adjustments are required**, turn the game OFF and back ON to return to the game over mode.

MAXIMUM PLUMB BOB TILTS

Function 32 controls the multiple tilt feature. The plumb bob tilt can be set so that the ball in play does not tilt the first time that the bob contacts the ring. All tilts do not have this capability.

To change the number of plumb bob tilts (1-9) proceed as follows:

1. If not already in test 04, enter test 04 in one of the following ways:
 - a. From the game over mode, set the AUTO-UP/MANUAL-DOWN switch to AUTO-UP and depress the ADVANCE pushbutton.
 - b. From diagnostics, set the AUTO-UP/MANUAL-DOWN switch to AUTO-UP and depress the ADVANCE pushbutton to advance the diagnostics to test 04.

2. Set the AUTO-UP/MANUAL-DOWN switch to the desired position and operate the ADVANCE pushbutton until Function 32 is indicated on the ball in play display.
3. **To increase** the number of plumb bob tilts, set the AUTO-UP/MANUAL-DOWN switch to AUTO-UP.
To decrease the number, set it to MANUAL-DOWN.
4. Operate the credit button until the desired number of plumb bob tilts is indicated on the player 1 display.
5. **If no further game adjustments are required**, turn the game OFF and back ON to return to the game over mode.

UNIQUE GAME ADJUSTMENTS

In STELLAR WARS, Function 33 controls playfield restore for the eject hole lamps and the bonus multiplier. Function 34 controls the game Extra Ball feature and Function 35 controls the optional sweep sound. With Function 33 set to 00 (factory setting) both the eject hole lamps and bonus multipliers below "5X" are restored for subsequent balls. With it set to 01, only the eject hole lamps are restored; with it set to 02, only the bonus multiplier is restored; and with it set to 03, neither feature is restored. With Function 34 set to 00 (factory setting) the game Extra Ball feature is enabled; with it set to 01, the feature is disabled and the eject hole Extra Ball when Lit lamp is never turned on. With function 35 set to 00 (factory setting), the optional sweep sound is turned off. Setting it to any value between 01 and 31 turns the sound on and selects the sound. The factory-recommended sound is selected by setting Function 35 to a value of 30.

1. If not already in test 04, enter test 04 in one of the following ways:
 - a. From the game over mode, set the AUTO-UP/MANUAL-DOWN switch to AUTO-UP and depress the ADVANCE pushbutton.
 - b. From diagnostics, set the AUTO-UP/MANUAL-DOWN switch to AUTO-UP and depress the ADVANCE pushbutton to advance the diagnostics to test 04.
2. Set the AUTO-UP/MANUAL-DOWN switch to the desired position and operate the advance pushbutton until Function 33 is indicated on the ball in play display.
3. **To raise** the value of Function 33, set the AUTO-UP/MANUAL-DOWN switch to MANUAL-DOWN.
To lower the value, set it to MANUAL-DOWN.
4. Operate the credit button until the desired value is indicated on the Player 1 display.
 - 00 - Eject Hole Lamps and Bonus Multiplier Restore
 - 01 - Eject Hole Lamps Restore
 - 02 - Bonus Multiplier Restores
5. Repeat steps 2, 3, and 4 to adjust Function 34 for Extra Ball Control.
 - 00 - Extra Ball Allowed
 - 01 - No Extra Ball
6. Repeat steps 2, 3, and 4 to adjust Function 35 for the sweep sound (00 - Sound off; when turned on a setting of 30 is recommended).
7. **If no further game adjustments are required**, turn the game OFF and back on to return to the game over mode.

RESTORING FACTORY SETTINGS

The factory settings are restored using the coin door switches and two switches on the CPU Board. Refer to Figures 5 and 6 and proceed as follows:

1. With the game in the game over mode, set the AUTO-UP/MANUAL-DOWN switch to MANUAL-DOWN and momentarily depress the ADVANCE pushbutton. All displays should go blank.
2. Remove the backglass and unlatch and open the insert door.
3. Set all switches on the MASTER COMMAND switch to OFF (move to the right).
4. Set switch 7 on the MASTER COMMAND switch to ON (move to the left).
5. Momentarily depress the MASTER COMMAND ENTER pushbutton. The LEDs should blink once.
6. Turn the game OFF and back ON two times to return to the game over mode.

- 04 Total Paid Credits
- 05 Total Number of Specials
- 06 Total Number of Credits or Extra Balls for Replay Scores
- 07 Match/High Score to Date Credits
- 08 Total Credits (Sum of 04-07 as applicable)
- 09 Total Extra Balls (Sum of Extra Ball features, and 05 and 06 as applicable)
- 10 Total Ball Time in Minutes
- 11 Total Number of Balls played
- 12 Current High Score to Date

SECTION 4 GAME BOOKKEEPING AND EVALUATION

This section provides an explanation of the built-in game bookkeeping features. The bookkeeping and game evaluation features consist of:

TEST 04 READOUT	DESCRIPTION
00	PROM Identification (Game No. and Revision level)
01	Coins Left Chute (Closest to coin door hinge)
02	Coins Center Chute
03	Coins Right Chute

FEATURE ACCESS

All of these features can be accessed from the coin door (See Figure 5). To obtain bookkeeping totals proceed as follows:

1. With the game in the **game over mode**, set the AUTO-UP/MANUAL-DOWN switch to AUTO-UP.
2. Momentarily depress the ADVANCE pushbutton. The game will go immediately to diagnostics test 04. The number of credits display indicates 04; the ball in play display indicates function 00, and the Player 1 display indicates the PROM identification (game number and revision level).

NOTE

If indications are not as stated, refer to troubleshooting procedures in Section 6.

3. Momentarily depress the ADVANCE pushbutton. Function 01 is indicated on the number of credits display and the number of coins through the left chute (closest to coin door hinge) is indicated on the Player 1 display.
4. Repeat step 3 to obtain the readings for functions 02 (coins through center chute), 03 (coins through right chute), and 04 (total paid credits).

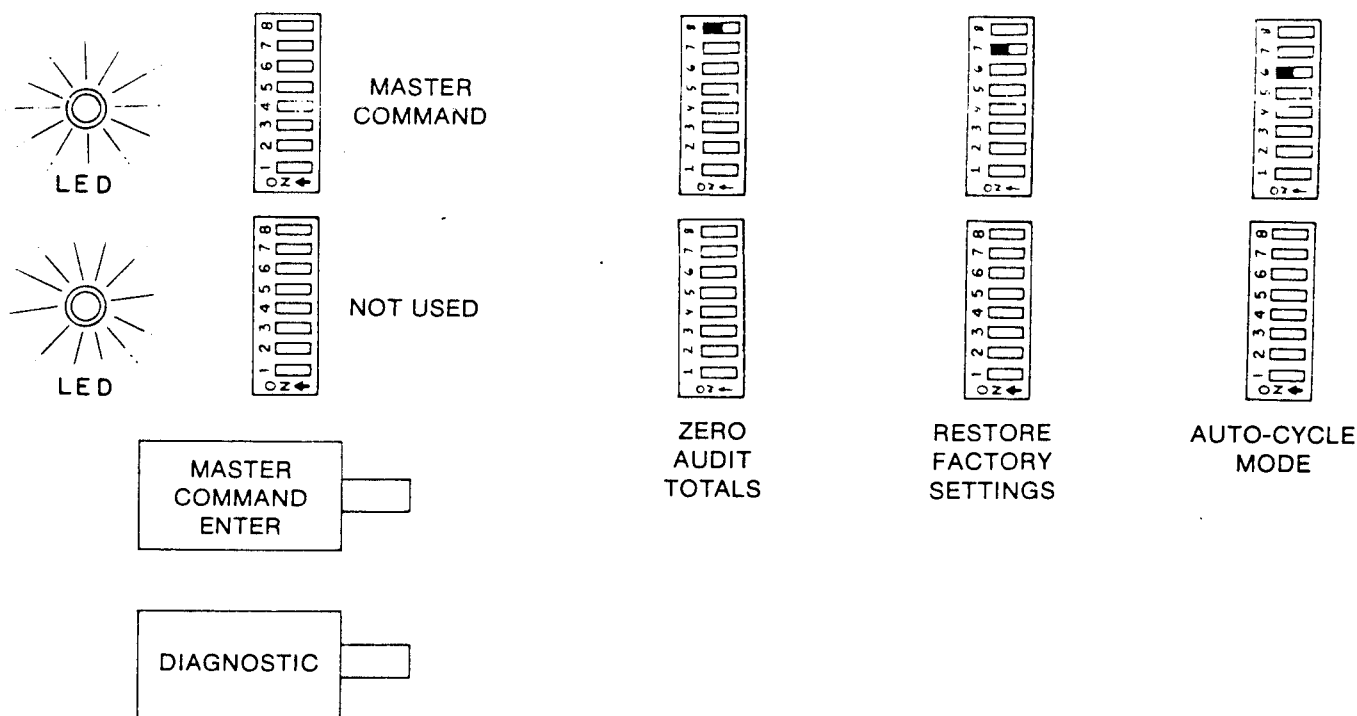

Figure 6. Master Command Switch Settings

NOTE

If it is desired to recheck a total that you have advanced past, set the AUTO-UP/MANUAL-DOWN switch to MANUAL-DOWN and operate the ADVANCE pushbutton. This will cause the function number to decrease (from 04 to 03, etc.)

5. Operate the ADVANCE pushbutton until Function 05 is indicated in the ball in play display. The total number of Special awards is indicated on the Player 1 display.
6. Operate the ADVANCE pushbutton until Function 06 is indicated in the ball in play display. The total number of credits or extra balls for replay scores is indicated in the Player 1 display.
7. Operate the ADVANCE pushbutton until Function 07 is indicated on the ball in play display. The total credits awarded for the Match and High Score to Date features is indicated on the player 1 display.
8. Operate the ADVANCE pushbutton until Function 08 is indicated on the ball in play display. The total credits (sum of paid credits and, as applicable, Functions 06 through 08).
9. The percentage of paid credits may be calculated as follows:

$$\text{Function 04} \div \text{Function 08} = \% \text{ paid credits}$$

10. Operate the ADVANCE pushbutton until Function 09 is indicated on the ball in play display. The total number of extra balls (sum of the game extra ball feature, Special, SUPER FLASH, and Function 06, as applicable).
11. Operate the ADVANCE pushbutton until Function 10 is indicated on the ball in play display. The total ball time in minutes is indicated on the player 1 display.
12. Operate the ADVANCE pushbutton until Function 11 is indicated on the ball in play display. The total number of balls is indicated on the player 1 display.
13. The average ball time in seconds may be calculated as follows:

$$\text{Function 10} \times 60 \div \text{Function 11} = \text{Average ball time in seconds}$$

14. Operate the ADVANCE pushbutton until Function 12 is indicated on the ball in play display. The current High Score to Date is indicated on the player 1 display.
15. Turn the game OFF and back ON to return to the game over mode. If desired, reset the High Score to Date to the backup value and reset the audit totals to zero as explained in the following paragraphs.

HIGH SCORE RESET

The current High Score to Date (Function 12) may be reset to the backup High Score to Date (Function 13) from the coin door. To adjust the backup High Score to Date, see Section 3. **With the game in the game over mode**, momentarily depress the HIGH SCORE RESET pushbutton.

RESETTING AUDIT TOTALS

Functions 01 to 11 may be reset to zero using switches located on the CPU Board. Refer to Figure 6, there are two 8-position miniature slide switches and two pushbutton switches located on the right side of the CPU Board. The lower 8-position switch is not used and the lower (DIAGNOSTIC) pushbutton switch is used only for

troubleshooting. Switch number 8 on the MASTER COMMAND slide switch is set to ON (moved to the left) and all other switches are set to OFF (moved to the right). Then the MASTER COMMAND ENTER pushbutton is depressed. To reset Function 01 through 11 to zero, proceed as follows:

1. **With the game in the game over mode**, set the coin door AUTO-UP/MANUAL-DOWN switch to MANUAL-DOWN.
2. Momentarily depress the ADVANCE pushbutton. All displays should go blank.
3. Unlock and remove the backglass and open the insert door.
4. Move all switches on the MASTER COMMAND slide switch to the right (OFF).
5. Move switch 8 on the MASTER COMMAND slide switch to the left (ON).
6. Momentarily depress the MASTER COMMAND ENTER pushbutton.
7. Close and latch the insert door and replace the backglass. Turn the game OFF and back ON to return to the game over mode.

**SECTION 5
BUILT-IN DIAGNOSTICS**

This section describes the built-in diagnostics used to test the displays, lamps, solenoids, and switches in the game. Control of diagnostics is from two switches in the coin door. An Auto-Cycle test, which is initiated by switches on the CPU Board, repeatedly tests the displays, lamps, and solenoids. Refer to Figure 7. In addition to the tests described in this section, there are CPU Board and Sound Board self-tests which are described in Section 6, Maintenance.

DISPLAY DIGITS TEST

This test allows a complete test of all the displays. Proceed as follows:

1. From the game over mode, set the AUTO-UP/MANUAL-DOWN switch on the coin door to MANUAL-DOWN.
2. Momentarily depress the ADVANCE pushbutton on the coin door. All displays should go blank.
3. Momentarily depress the ADVANCE pushbutton again. All displays should indicate all 0's.
4. Repeat step 3, as desired. The indication on the displays should sequence to all 1's, 2's, ... 9's, and 0's ...
5. If no further tests are required, turn the game OFF and back ON to return to the game over mode.

LAMP TEST—TEST 01

This test causes all multiplexed lamps to blink on and off. Note that general illumination lamps are not controlled by this test or by any test. Proceed as follows:

1. Enter the Lamp Test in one of the following ways:
 - a. From the Display Digits test, set the AUTO-UP/MANUAL-DOWN switch to AUTO-UP and momentarily depress the ADVANCE pushbutton.

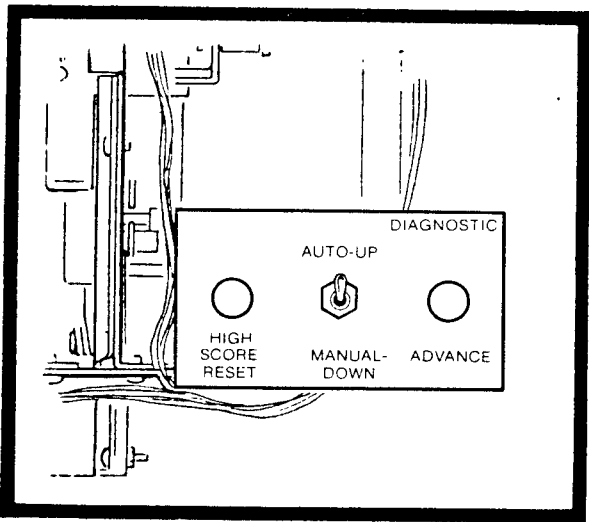
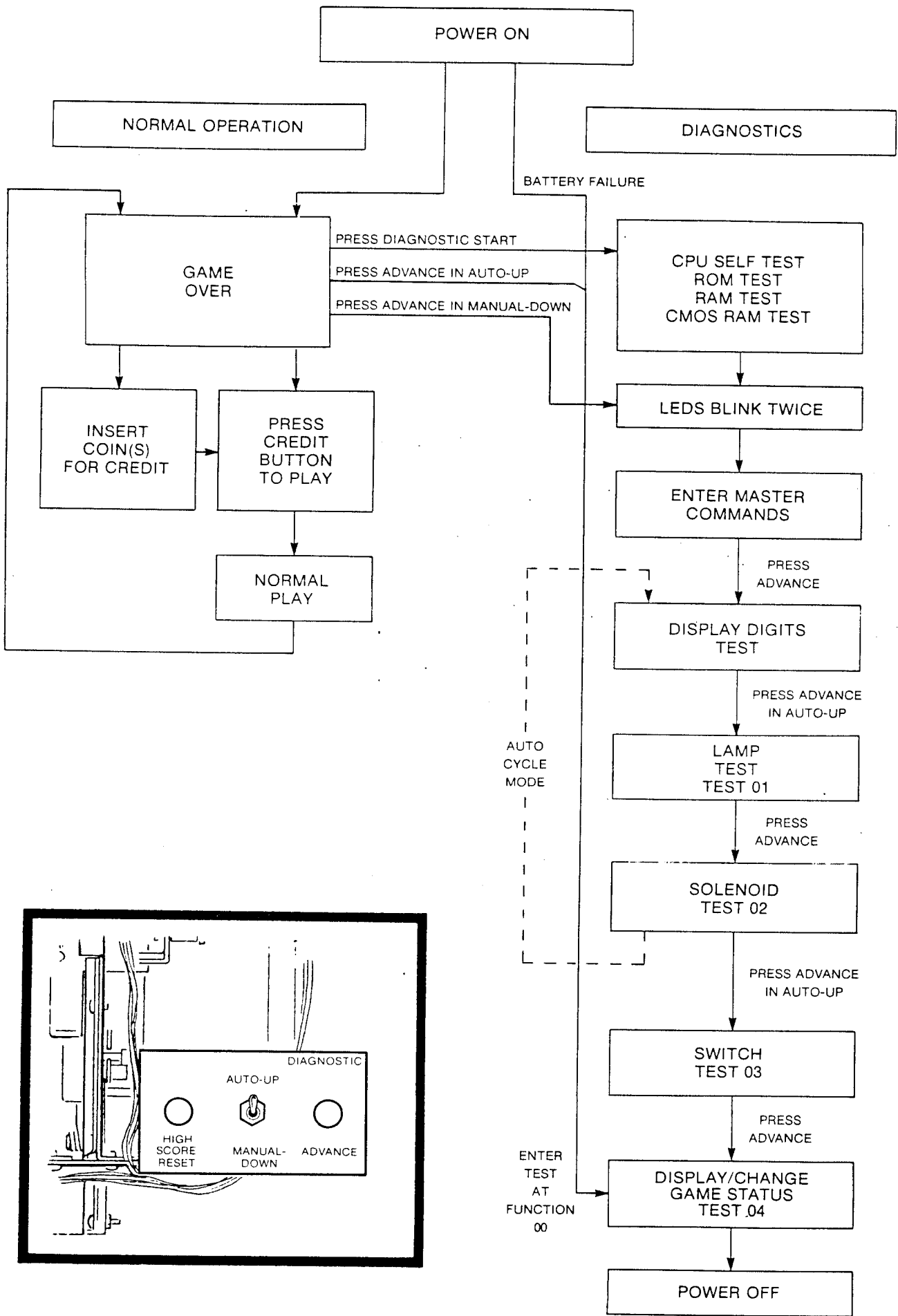

Figure 7. Normal Operation and Diagnostic Flow Chart

- b. From the game over mode,
- (1) Set the AUTO-UP/MANUAL-DOWN switch to MANUAL-DOWN and momentarily depress the ADVANCE pushbutton.
 - (2) Set the switch to AUTO-UP and operate the ADVANCE pushbutton until 01 is indicated on the number of credits display.

The multiplexed lights should blink on and off.

2. If no further tests are required, turn the game OFF and back ON to return to the game over mode.

SOLENOID TEST—TEST 02

This test permits checking of all solenoids by causing the Driver Board to pulse each solenoid. Refer to Table 3 and proceed as follows:

1. Enter the Solenoid Test in one of the following ways:
 - a. From the Display Digits or Lamp Test, set the AUTO-UP/MANUAL-DOWN switch to AUTO-UP and operate the ADVANCE pushbutton until 02 is indicated on the number of credits display.
 - b. From the game over mode,
 - (1) Set the AUTO-UP/MANUAL-DOWN switch to MANUAL-DOWN and momentarily depress the ADVANCE pushbutton.
 - (2) Set the switch to AUTO-UP and operate the ADVANCE pushbutton until 02 is indicated in the number of credits display.

The ball in play display should indicate each solenoid number as it is being pulsed.

2. To repeatedly pulse solenoids one at a time set the switch to MANUAL-DOWN and momentarily depress the ADVANCE pushbutton. The solenoid number indicated in the ball in play display should be pulsed repeatedly.
3. Each time the ADVANCE pushbutton is depressed, the next solenoid will be indicated in the ball in play display and will be pulsed.
4. If no further tests are required, turn the game OFF and back ON to return to the game over mode.

Table 3. Solenoids

SOLENOID NO.

- | | | |
|-----|---------------------------------|---|
| 1. | Ball Release | |
| 2. | Left 3-Bank Drop Targets Reset | |
| 3. | Eject Hole | |
| 4. | 4-Bank Left Drop Targets Reset | |
| 5. | 4-Bank Right Drop Targets Reset | |
| 6. | Right 3-Bank Drop Targets Reset | |
| 7. | Bottom Right Jet Bumper | |
| 8. | Flash Lamps* | |
| 9. | Sound | |
| 10. | Sound | |
| 11. | Sound | |
| 12. | Sound | |
| 13. | Sound | |
| 14. | Credit Knocker | |
| 15. | Not Used | |
| 16. | Coin Lockout | |
| 17. | Bottom Left Jet Bumper | |
| 18. | Left Kicker | *Flash lamps glow dimly as part of normal operation |
| 19. | Top Left Jet Bumper | |
| 20. | Top Right Jet Bumper | |
| 21. | Top Center Jet Bumper | |
| 22. | Right Kicker | |

SWITCH TEST—TEST 03

This test permits checking of all multiplexed switches in the game. Refer to Figure 8 and proceed as follows:

1. Enter the Switch Test in one of the following ways:
 - a. From the Display Digits, Lamp, or Solenoid Tests, set the AUTO-UP/MANUAL-DOWN switch to AUTO-UP and operate the ADVANCE pushbutton until 03 is indicated on the number of credits display.
 - b. From the game over mode,
 - (1) Set the AUTO-UP/MANUAL-DOWN switch to MANUAL-DOWN and momentarily depress the ADVANCE pushbutton.
 - (2) Set the switch to AUTO-UP and operate the ADVANCE pushbutton until 03 is indicated on the number of credits display.

All stuck switches will be sequentially indicated on the ball in play display. If there are no stuck switches, the display will be blank.

2. Actuate each switch and check for the proper switch number on the ball in play display.
3. If it is desired to change game adjustment or review game status, refer to Section 3, Game Adjustments. Otherwise, turn the game OFF and back ON to return to the game over mode.

AUTO CYCLE MODE

This mode is provided to help diagnose intermittent problems by continuously performing the Display Digits, Lamps, and Solenoid Tests. Each cycle of this mode sequences through the display tests, flashes the lamps 64 times, and pulses each solenoid. This mode is initiated by using the coin door switches and two switches on the CPU Board. Refer to Figures 5 and 6 and proceed as follows:

1. **With the game in the game over mode**, set the AUTO-UP/MANUAL-DOWN switch to MANUAL-DOWN and momentarily depress the ADVANCE pushbutton. All displays should go blank.
2. Remove the backglass and unlatch and open the insert door.
3. Set all switches on the MASTER COMMAND slide switch to OFF (move to the right).
4. Set switch 6 to ON (move to the left).
5. Momentarily depress the MASTER COMMAND ENTER pushbutton. The LED's should blink once.
6. Set the AUTO-UP/MANUAL-DOWN switch to AUTO-UP and momentarily depress the ADVANCE pushbutton. The Auto Cycle mode should start with the display digits test.
7. To gain manual control during the Display Digits Test, momentarily depress the ADVANCE pushbutton with the toggle switch set to MANUAL-DOWN.
8. To return to the Auto Cycle mode, set the toggle switch to AUTO-UP and momentarily depress the ADVANCE pushbutton.
9. To gain manual control during the Solenoid test, momentarily depress the ADVANCE pushbutton with the toggle switch set to MANUAL-DOWN.
10. To return to the Auto Cycle mode, set the toggle switch to AUTO-UP.

**SWITCH
NO.**

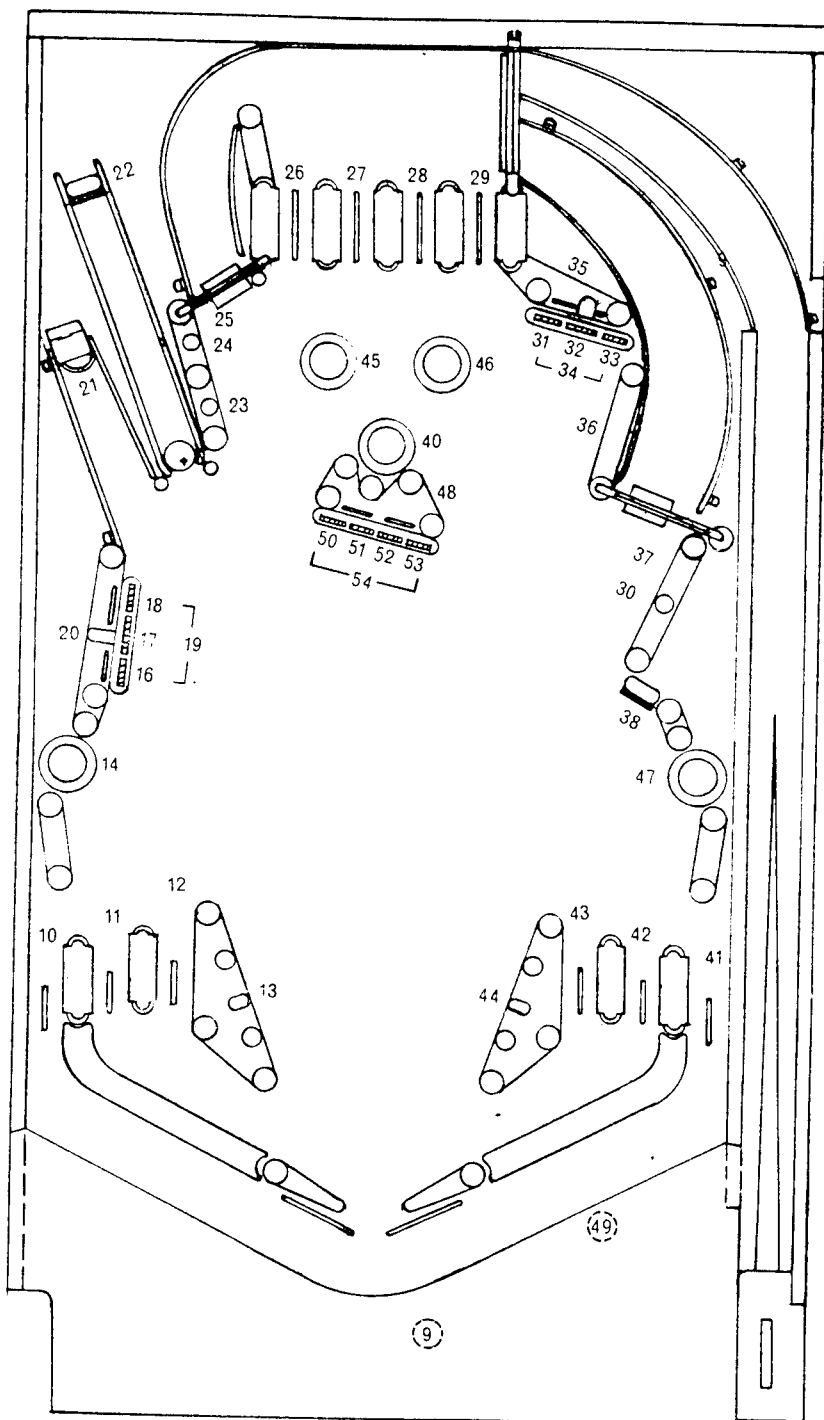

- 01 Plumb Bob Tilt
- 02 Ball Roll Tilt
- 03 Credit Button
- 04 Right Coin Switch
- 05 Center Coin Switch
- 06 Left Coin Switch
- 07 Slam Tilt
- 08 High Score Reset
- 09 Outhole
- 10 Left Special
- 11 "W" Rollover
- 12 "A" Rollover
- 13 Left Kicker
- 14 Bottom Left Jet Bumper
- 15 Not Used
- 16 Left 3-Bank, Bottom Drop Target
- 17 Left 3-Bank, Center Drop Target
- 18 Left 3-Bank, Top Drop Target
- 19 Left 3-Bank Drop Target Series
- 20 Left 3-Bank Standup
- 21 Eject Hole
- 22 Captive Ball Target
- 23 Lower Top Left Standup
- 24 Upper Top Left Standup
- 25 Left Spinner
- 26 "1" Rollover
- 27 "2" Rollover
- 28 "3" Rollover
- 29 "4" Rollover
- 30 Middle Right Standup
- 31 Top 3-Bank, Left Drop Target
- 32 Top 3-Bank, Center Drop Target
- 33 Top 3-Bank, Right Drop Target
- 34 Top 3-Bank, Drop Target Series
- 35 Top 3-Bank Series
- 36 Top Right Standup
- 37 Right Spinner
- 38 Right Bull's-Eye Target
- 39 Not Used
- 40 Top Center Jet Bumper
- 41 Right Special
- 42 "S" Rollover
- 43 "R" Rollover
- 44 Right Kicker
- 45 Top Left Jet Bumper
- 46 Top Right Jet Bumper
- 47 Lower Right Jet Bumper
- 48 Center Standup
- 49 Playfield Tilt
- 50 4-Bank, Left Drop Target
- 51 4-Bank, Left Center Drop Target
- 52 4-Bank, Right Center Drop Target
- 53 4-Bank, Right Drop Target
- 54 4-Bank, Series

Figure 8. Playfield Switch Locations and Switch Chart

11. To exit the Auto Cycle mode and advance to Switch Test 03, set the toggle switch to AUTO-UP and depress the ADVANCE pushbutton during the Solenoid Test. Operation is now as previously described for Test 03.
12. To terminate the Auto-Cycle mode and go to game over, turn the game OFF and back ON.

SECTION 6 MAINTENANCE

This section provides procedures for board replacement, CPU and Sound Board self-tests, and troubleshooting procedures. For any problems first perform the CPU Board Self-Tests. For sound problems also perform the Sound Board Self-Test. After performing the self-test(s), refer to the troubleshooting charts that follow.

BOARD REPLACEMENT

CPU Board

To remove the CPU Board, the Driver Board must first be unmounted. If the replacement board is not equipped with STELLAR WARS PROMs and yellow-labeled ROMs, the PROMs and ROMs must be removed from the old board. In any event, the replacement board **MUST BE EQUIPPED WITH THREE PROM SOCKETS**. To replace the CPU Board, proceed as follows:

1. Turn the game OFF.
2. Remove the six screws and star washers that secure the driver board to its mounting bracket.
3. Carefully unplug the Driver Board from the CPU Board.
4. Disconnect the seven plugs from the CPU Board.
5. Remove the two screws and star washers that secure the top of the CPU Board to its mounting bracket in the backbox. (The bottom of the board is secured by a groove in the bracket.)
6. Lift the CPU Board up and remove it from the backbox.
7. Inspect the PROMs and ROMs.
 - a. If the replacement board does not have STELLAR WARS PROMs, remove the PROMs and insert the PROMs from the old CPU Board into the sockets on the replacement board. Make sure that the notches on the PROM #1 and #2 chips are facing down and the PROM #3 chip notch is facing left.
 - b. If the replacement board does not have yellow-labeled ROMs, remove the ROMs and insert the yellow-labeled ROMs from the old CPU Board into the sockets on the replacement board. Make sure that the notches on the chips are facing down and that ROM #1 is in the third socket from the left.
8. Set the replacement CPU Board into the groove in the bracket and secure it at the top with the two screws and star washers removed in step 5.
9. Reconnect the cables disconnected in step 4 using the keys and cut-off pins as a guide. Make sure that the pins are aligned, the connectors are firmly seated, and that no pin terminations have been pushed out of the plugs.

10. Carefully plug the Driver Board onto the CPU Board and mount the Driver Board to the bracket using the six screws and star washers removed in step 2.
11. Turn the game ON and perform the CPU Board Self-Test procedures.

Driver Board

Proceed as follows:

1. Turn the game OFF.
2. Disconnect the 12 plugs from the board.
3. Remove the six screws and star washers that secure the board to its mounting bracket.
4. Carefully unplug the Driver Board from the CPU Board and remove the Driver Board.
5. Align the replacement board over the pins on the CPU Board and carefully plug it onto the CPU Board.
6. Secure the board to the mounting bracket using the six screws and star washers removed in step 3.
7. Reconnect the cables disconnected in step 2 using the keys and cut-off pins as a guide. Make sure that the pins are aligned, the connectors are firmly seated, and that no pin terminations have been pushed out of the plugs.
8. Turn the game ON and perform Lamp, Solenoid, and Switch tests in accordance with procedures provided in Section 5.

Power Supply Board

Proceed as follows:

1. Turn the game OFF.
2. Unplug the six cables from the board.
3. Remove the six screws and star washers that secure the board to its mounting bracket.
4. Position the replacement board on the mounting bracket and secure with the six screws and star washers removed in step 2.
5. Reconnect the six cables unplugged in step 2.
6. Turn the game ON and check power supply voltage using Table 4 as a guide.

Master Display Board

Proceed as follows:

1. Turn the game OFF.
2. Unplug the seven cables from the board.
3. Remove the four nuts and lockwashers that secure the board to the nylon spacers on the insert door and remove the board.
4. Position the replacement board on the spacers and secure it using the four nuts and lockwashers removed in step 3.
5. Reconnect the seven cables unplugged in step 2.
6. Turn the power ON and perform the display digits test in accordance with procedures provided in Section 5.

Table 4. Typical Voltage Measurements

VOLTAGE	METER SETTING	MEASURE ACROSS	TYPICAL READING
Unregulated Logic Supply	+50V dc	(+) F5 (-) Ground	+11V dc
Logic B+	+10V dc	(+) 3J5-1 (Gray Lead) (-) Ground	+5.1V dc
Lamp Supply	+50V dc	(+) F3 (-) Ground	+18V dc
Solenoid Supply	+50V dc	(+) F2 (-) Ground	+40V dc
Display Voltage	+250V dc	(+) 3J5-4 (Brown-White lead) (-) Ground	+100V dc
	-250V dc	(+) 3J5-3 (Orange and White- Black Leads) (-) Ground	-100V dc
General Illumination	10V ac	(+) Fuse Card Fuse (-) Fuse Card Terminal	6.3V ac

Slave Display Board

Proceed as follows:

1. Turn the game OFF.
2. Unplug the cable connected to the board.
3. Remove the four nuts and lockwashers that secure the board to the nylon spacers on the insert door and remove the board.
4. Position the replacement board on the spacers and secure it using the four nuts and lockwashers removed in step 3.
5. Reconnect the cable unplugged in step 3.
6. Turn the game ON and perform display digits test in accordance with procedures provided in Section 5.

Sound Board

When replacing the Sound Board, the replacement board must be checked to make sure it has Sound ROM 1 installed and has jumpers for ROM operation. In addition, modification may be required to the Sound Board. Two areas may require modification. The first reduces susceptibility of the Sound Board to noise and consists of adding two resistors and a jumper. The second improves the quality of the sound at the speaker and consists of changing two resistor values. Proceed as follows:

1. Turn the game OFF.
2. Unplug the three cables from the Sound Board.

3. Remove the four screws and star washers that secure the board to its mounting bracket and remove the board.
4. If the replacement board is not equipped with Sound ROM 1, remove the ROM from the old board and insert it into the replacement board. Make sure that the notch in the chip is at the right side.
5. Refer to Figure 9 and check the jumpers on the replacement board. If the replacement board is not jumpered as indicated, remove the four jumpers from the replacement board and connect four new jumpers.
6. Inspect the replacement board. If it is equipped with two fuses or if the modification indicated in Figure 9 have already been made, proceed to step 11.
7. Connect a jumper on the solder side of the board between pins 39 and 40 of 1C3.
8. Obtain two 10K, 10%, 1/4-Watt resistors and connect them as indicated in the unused IC pad. This completes the modification to reduce susceptibility to noise. Steps 9 and 10 improve the sound quality.
9. Unsolder and remove R14 and R23 (100K).
10. Obtain two 4.7K, 10%, 1/4-Watt resistors and solder them in place of the resistors removed in step 9.
11. Position the replacement board on its mounting bracket and secure it using the four screws and star washers removed in step 3.
12. Reconnect the three cables unplugged in step 2.
13. Turn the game ON and perform the Sound Board Self-Test procedure.

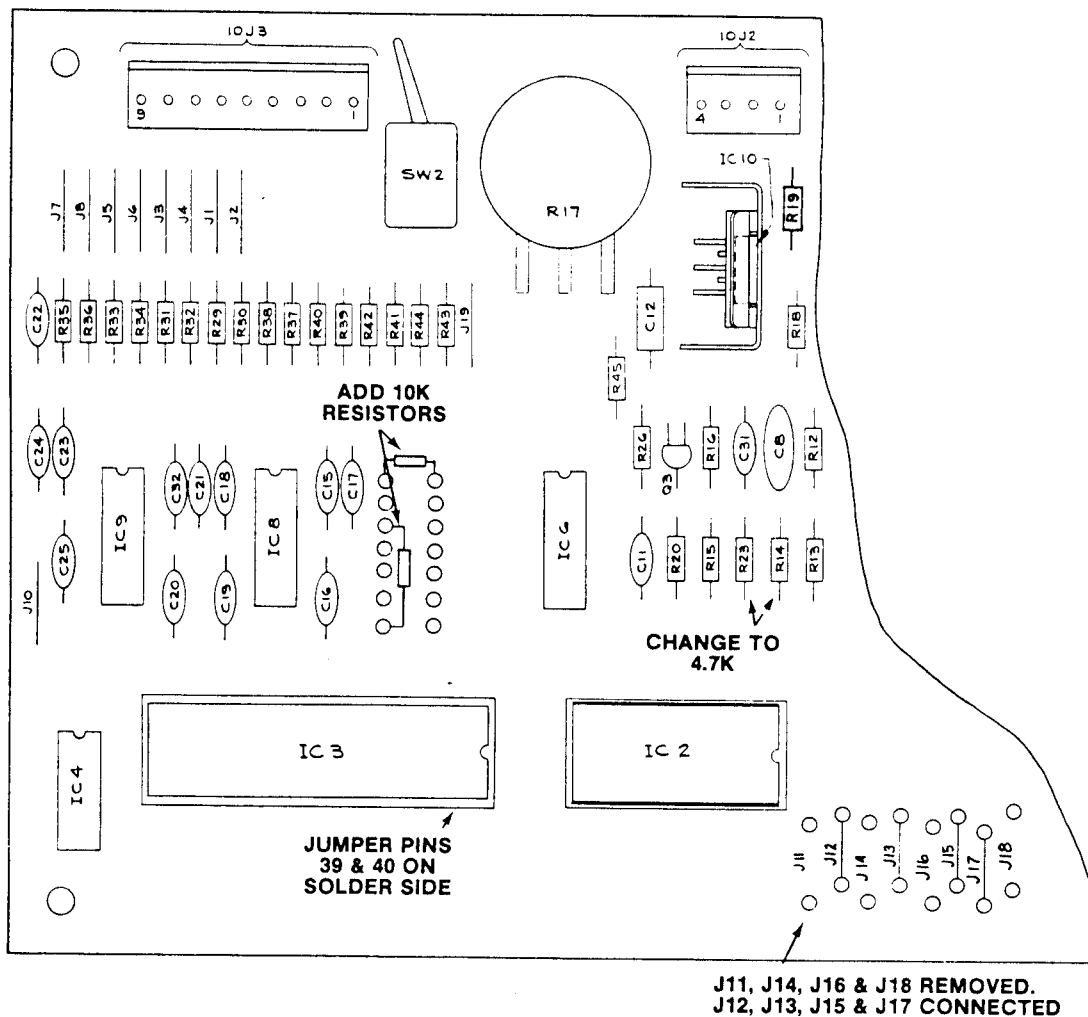

Figure 9. Sound Board Modification and ROM Jumper Details

CPU BOARD SELF-TEST

A pushbutton switch on the CPU board is used to initiate the CPU Board Self-Test. The coin door must be open to perform this test. Successful completion of the test is indicated by the LEDs blinking twice. Failure of a test is indicated by one or both of the LEDs lighting and staying lit. Proceed as follows:

1. Open the coin door.
2. With the game turned ON, locate the DIAGNOSTIC pushbutton on the right side of the CPU board.
3. Momentarily depress the DIAGNOSTIC pushbutton. The LEDs should blink twice and all displays should go blank.
4. For the following indications of the LEDs, proceed as follows:

OFF ○ Indicates ROM/PROM failure; one or more of IC17, IC20, IC21, IC22, and IC26 are faulty. Isolate the faulty chip(s) by substitution.

ON ● Indicates RAM failure (IC13 or IC16), replace the CPU Board.

ON ● Indicates CMOS RAM (IC19) or PIA I (IC18) failure. Replace the CPU Board.

5. If the LEDs come on and stay on when the game is first turned ON or the LEDs remain off when the DIAGNOSTIC pushbutton is depressed, refer to Table 13 in the troubleshooting charts that follow.

SOUND BOARD SELF-TEST

The Sound Board Self-Test exercises Sound Board circuitry and causes a continuous sound to be emitted. This sound can be used for checking amplifier circuitry and for adjusting the volume. Proceed as follows:

1. Perform CPU Board Self-Tests.
2. Momentarily depress the diagnostic pushbutton on the Sound Board.
3. If no sound is produced check the setting of the volume control and the power and speaker connections to the Sound Board. Also check that the jumper connector 10P4 is in place. If this does not resolve the problem or if a sound is produced from the self-test, refer to Table 14 in the troubleshooting charts that follow.

TROUBLESHOOTING CHARTS

Tables 5 through 14 are used in conjunction with the diagnostic test described in Section 5 to isolate problems and repair faulty games. For specific problems with:

Lamps—See Table 5
Switches—See Table 6
Solenoids—See Table 7

Master Display—See Table 8
Player Display—See Table 9
Game Operation—See Table 10
Game does not operate or blows fuses—See Table 11
Losing memory—See Table 12
No response to CPU Self-Tests or intermittent operation
See Table 13
Sound—See Table 14

Table 5. Lamps
(Place Diagnostics in Test 01)

1 LAMP	4-8 LAMPS	ALL LAMPS	GENERAL ILLUMI.
Always OFF 1. Check Bulb 2. Check Diode (Observe Polarity) 3. Check wiring (broken wires) Glows DIM 1. Check Bulb (correct #bulb) 2. Check Diode (Observe Polarity) 3. Check wiring (shorted wires) Always ON 1. Check Diode (Observe Polarity) 2. Check wiring (shorted wires)	Always OFF 1. Check wiring (broken wires) 2. Check Connectors (2J5, 2J7) 3. Replace Driver Board Glows DIM 1. Check wiring (broken wires) 2. Check Diode 3. Check Connectors (2J5, 2J7) 4. Replace Driver Board Always ON 1. Check wiring (shorted wires) 2. Check Diodes 3. Check Connectors (2J5, 2J7) 4. Replace Driver Board	Always OFF 1. Check fuse 3F3 on Power Supply 2. Check for +18 VDC on fuse 3F3 to ground 3. Check Connector 3J4 4. Check Connector 8P2/8J2 5. Check wiring (broken or shorts) 6. Replace Driver Board Glows DIM 1. Check line voltage 2. Check for +18 VDC on fuse 3F3 to ground	Always ON Normal Condition Always OFF 1. Check Fuse on Fuse Card 2. Check for +6.3 VAC 3. Check Connectors (3J3) 4. Check Connectors 9P1 and 8P2/8J2 5. Check wiring (broken or short) Glows DIM 1. Check line voltage
All lamps are N44 or equivalent All diodes are 1N4001 or equivalent			

Table 6. Switches
(Place Diagnostics in Test 03)

1 SWITCH	4-8 SWITCHES	ALL SWITCHES
Always Actuated 1. Check contacts 2. Check shorted wires Never Actuates 1. Check adjustment 2. Check broken wires 3. Check for open diode by jumpering across diode and actuating.	Always Actuated 1. Check adjustments 2. Check shorted wires on playfield or to 2J2, 2J3 3. Replace Driver Board Never Actuated 1. Check adjustment 2. Check broken wires on playfield or 2J2, 2J3 3. Check plug 8P1/8J1 for broken wires or pushed out pins 4. Replace Driver Board	Switch Closure Displays Multiple Switch Numbers 1. Check adjustments 2. Check shorted wires on playfield or to 2J2, 2J3 3. Replace Driver Board Switch Displays Incorrect No. 1. Check correct switch chart for game and check adjustment 2. Incorrect wiring on playfield 2J2, 2J3, or 8P1/8J1 3. Check Connector keying
1. Check adjustments 2. Check Connectors 2J2, 2J3, are not exchanged 3. Replace Driver Board		

Table 7. Solenoids
(Place Diagnostics in Test 02)

1 SOLENOID		ALL SOLENOIDS
Never Actuates 1. Check solenoid Chart to verify number correct and in use 2. Broken wire to solenoid 3. Shorted diode across solenoid 4. Shorted/burned out solenoid 5. Open driver for that solenoid—replace Driver Board	Always Actuated 1. Shorted wire for that solenoid 2. Shorted driver for that solenoid on Driver Board—replace Driver Board	Never Actuated 1. Check for +28 VDC on Power Supply fuse 3F2 to ground 2. Check fuse 3F2 on Power Supply 3. Check Connectors 3J3 and 3J4 on Power Supply 4. Check Connector 2J9, 2J10, 2J11, 2J12 for broken/shorted wires. 5. Replace Driver Board
FLIPPERS		
ONE FLIPPER	BOTH FLIPPERS	
Never Operates 1. Switch contacts on flipper button open or out of adjustment. 2. Shorted diode across coil. Flipper Weak 1. Switch contacts on flipper button out of adjustment or pitted contacts. 2. End of stroke switch on solenoid not adjusted properly. 3. Check connections on solenoid and check for bind.	Never Operate 1. Check Fuse 8F1 on Playfield and 6P2 connection. 2. Diode or resistor in driver circuit shorted. 3. Relay 2Z1 on driver board faulty. 4. Other fault in driver circuit. Replace driver board. Operates with Game Over, etc. 1. Replace Driver Board	

Table 8. Master Display
(Place Diagnostics in Display Digits Test)

USE EXTREME CAUTION WHEN MEASURING HIGH VOLTAGES!!!	
NO DISPLAY	INCORRECT DISPLAY
1. Check -100 VDC, +100 VDC & fuse 3F1 on Power Supply. 2. Check connectors 3J5, 4J7, 4J5, 1J3, 1J5, 1J6, 1J7 3. Check for +100 VDC and -100 VDC on connector 4J7—replace Power Supply Board if voltage incorrect 4. Replace Master Display Board.	1. Check +100 VDC, -100 VDC at 4J7 2. Check for broken or shorted wires on 4J5, 4J6, 1J5, 1J6, 1J7 3. Replace Master Display Board

Table 9. Player Display
(Place Diagnostics in Display Digits Test)

USE EXTREME CAUTION WHEN MEASURING HIGH VOLTAGES!!!	
1 PLAYER DISPLAY INCORRECT/OFF	2-4 PLAYER DISPLAYS INCORRECT/OFF
1. Check correct location of connector from Master Display Board. 2. Replace Player Display—if still incorrect, replace Master Display Board.	1. Check correct location of connectors from Master Display Board 2. Check voltage +100 VDC and -100 VDC on connector 4J7 3. If voltages are correct—replace Master Display Board.

Table 10. Game Operation and Adjustments

GAME OPERATION	ADJUSTMENTS	
<ol style="list-style-type: none"> 1. Play game manually to verify problem. 2. Review Section 2, Game Operation. 3. Place in Diagnostics Test 04; review and change game adjustments to that desired. 	<p>No Control from Coin Door Diagnostic Switches</p> <ol style="list-style-type: none"> 1. Check cabling for the switches in 7P1, 7P2, and 1P4. 2. Check for stuck Credit button switch. 3. Replace CPU Board. 	<p>Unable to Adjust Setting</p> <ol style="list-style-type: none"> 1. Check for open Credit button switch 2. Replace CPU Board.

Table 11. Inoperative or Blows Fuses

MACHINE INOPERATIVE		
<ol style="list-style-type: none"> 1. Remove plug from wall outlet and measure wall voltage. 2. With machine unplugged, check the line fuse, line cord, and ON/OFF switch with an Ohmmeter for continuity. 3. Check for any loose connections on line filter, ON/OFF switch. 4. Check that power connector to transformer is securely connected. 5. Check all fuses on power supply board. 6. Plug machine in, turn on and check voltage on power supply board fuses. 		
MACHINE BLOWS FUSE		
<p>Wall Fuse or Circuit Breaker Fuse</p> <ol style="list-style-type: none"> 1. Disconnect wall plug. 2. Disconnect connector from line filter to transformer. 3. Check line cord with Ohmmeter for shorts. 4. Check varistor and line filter for shorts. 5. Plug cord in wall and see if wall fuse still blows - if yes, disconnect whatever else is on same wall plug circuit and repeat steps 3 and 4 above. 	<p>Machine Fuse</p> <ol style="list-style-type: none"> 1. Check for correct fuse rating. 2. Check varistor, line filter, line cord for shorts. 3. Disconnect connector from line filter to transformer and try another fuse. 4. If fuse still blows, repeat steps 1-3. 5. If fuse does not blow, disconnect 3P1 and 3P2 plugs from the power supply board and reconnect plug from line filter to transformer. 6. If fuse blows, check transformer and both lamps and solenoid rectifiers for shorts. 7. If fuse does not blow, plug in 3P2 and 3P1 then try again. If fuse now blows, disconnect 3P3, 3P4, 3P5, 3P6, and try another fuse. If fuse still blows replace Power Supply. 8. If fuse doesn't blow, hook up 3P3, 3P4, 3P5, and 3P6 one at a time. If fuse blows when any one is plugged, look for burned out solenoid, dead shorts, etc. 	<p>Individual Power Supply Fuse</p> <ol style="list-style-type: none"> 1. Disconnect load from portion of the power supply that blows the fuse by disconnecting the appropriate plug. <ol style="list-style-type: none"> a. 3F1 (+100 VDC, -100 VDC) disconnect 3P5 b. 3F2 (+28 VDC) disconnect 3P4, 3P3 c. 3F3 (+18 VDC) disconnect 3P4 d. 6F1 (6.3 VAC) disconnect 7P1, 8P2 e. 3F5 (+5 VDC) disconnect 3P6 2. If fuse still blows, replace Power Supply. 3. If fuse does not blow, check for shorts in wiring, burned out solenoids, etc.

Table 12. Losing Memory

GAME COMES UP IN TEST 04 WHEN TURNED ON	GAME GOES TO DIAGNOSTICS FROM GAME OVER OR DURING PLAY
<ol style="list-style-type: none"> 1. Check that the batteries are properly seated. 2. Turn game OFF and wait 30 seconds. 3. Check battery voltage from the anode of 1D17 to ground. If less than 3.9 VDC, replace the batteries. 4. Check battery voltage from cathode of 1D17 to ground. If less than 3.2 VDC, replace diode and recheck voltage. 5. Replace CPU Board. 	<p>Perform procedures for intermittent operation provided in Table 13.</p>

Table 13. No Response to CPU Self-Test or Intermittent Operation

LEDs REMAIN ON AFTER POWER TURN-ON	LEDs DO NOT FLASH AND REMAIN OFF WHEN DIAGNOSTIC SWITCH DEPRESSED	INTERMITTENT OPERATION
<ol style="list-style-type: none"> 1. Check +5 VDC and Unregulated Logic B+ on CPU and Power Supply Boards. (See Table 4.) If low: <ol style="list-style-type: none"> a. Check ac input from transformer. b. Check wiring from transformer to 3P1-10, -11, and -12. c. Check 3D6 and 3D7. d. Replace Power Supply Board. 2. Turn game OFF and completely remove Driver Board from the backbox. Reapply power and depress the DIAGNOSTIC push-button on the CPU Board. If the LEDs blink twice and then remain OFF, replace the Driver Board. Otherwise, replace the CPU Board. 	<ol style="list-style-type: none"> 1. Turn game OFF and back ON. 2. If problems persist, check +5 VDC from power supply. If ok, replace CPU Board. 	<ol style="list-style-type: none"> 1. Make checks described in step 1 for LEDs remaining on after power turn-on. 2. Replace CPU Board.

Table 14. Sound Problems
(Place Diagnostics in Test 02)

1 OR MORE SOUNDS	ALL SOUNDS
<ol style="list-style-type: none"> 1. Broken wire to 10J3 connector. 2. Replace ROM on Sound Board. 3. Open driver on Driver Board; replace driver on Driver Board. 4. Open Buffer on Sound Board; replace buffer on Sound Board. 5. Replace Sound Board 	<p>Never Sound</p> <ol style="list-style-type: none"> 1. Check fuses 10F1 and 10F2 on Sound Board and 7F2 adjacent to Sound Board. 2. Check connectors 10J1, 10J2, 10J3 and 10J4. 3. Check volume control position. 4. Check amplifier portion of Sound Board. 5. Replace ROM on Sound Board. 6. Remove connector 10P3 and momentarily ground one of the used input pins of 10J3. If a sound is produced, a solenoid driver transistor is stuck on. Repair or replace Driver Board. 7. Replace Sound Board.

**SECTION 7
INTERCONNECTION CHARTS**

The following interconnection charts are used to identify the color and pin number of all the wires for all the components. The following conventions are used throughout—

1. 1J1 is connector J1 on board 1.
3J6 is connector J6 on board 3.
2. J designations refer to the male part of plug.
P designations refer to the female part of plug.
3. The Prefix numbers are as follows:

1. CPU Board
2. Driver Board
3. Power Supply Board
4. Master Display Board
5. Slave Display Board
6. Back Box Miscellaneous
7. Cabinet
8. Playfield
9. Insert Board
10. Sound Board

Refer to Figures 10 and 11 for the lamp and switch matrixes and to Table 15 for Solenoid assignments. Figure 12 provides identification of connectors used in the game.

ROW \ COLUMN	1	2	3	4	5	6	7	8
	YEL-BRN	YEL-RED	YEL-ORN	YEL-BLK	YEL-GRN	YEL-BLU	YEL-VIO	YEL-GRY
1	RED-BRN FIRE AGAIN	"W"	OUTLANE SPECIALS (2)	"W" ROLLOVER	SPINNERS (2)	"2" BONUS	NOT USED	#1 PLAYER UP
2	RED-BLK "S"	"A"	BULL'S EYE TARGET SPECIAL	"A" ROLLOVER	"X2"	"3" BONUS	1 CAN PLAY	#2 PLAYER UP
3	RED-ORN "T"	"R"	EJECT HOLE EXTRA BALL	"R" ROLLOVER	"X3"	"4" BONUS	2 CAN PLAY	#3 PLAYER UP
4	RED-YEL "E"	"S"	CAPTIVE BALL	"S" ROLLOVER	"X4"	"5" BONUS	3 CAN PLAY	#4 PLAYER UP
5	RED-GRN "L"	EJECT HOLE 2000	"1"	BOTTOM JET BUMPERS (2)	"X5"	"6" BONUS	4 CAN PLAY	TILT
6	RED-BLU "L"	EJECT HOLE 5000	"2"	TOP LEFT JET BUMPER	"10" BONUS	"7" BONUS	MATCH	GAME OVER
7	RED-VIO "A"	EJECT HOLE 10,000	"3"	TOP CENTER JET BUMPER	"20" BONUS	"8" BONUS	BALL IN PLAY	SHOOT AGAIN
8	RED-GRY "R"	NOT USED	"4"	TOP RIGHT JET BUMPER	"1" BONUS	"9" BONUS	CREDITS (PLAYFIELD)	HIGH SCORE

Figure 10. Lamp Matrix

ROW \ COLUMN	1	2	3	4	5	6	7	8
	GRN-BRN	GRN-RED	GRN-ORN	GRN-YEL	GRN-BLK	GRN-BLU	GRN-VIO	GRN-GRY
1	WHT-BRN 1 PLUMB BOB TILT	9 OUTHOLE	17 LEFT 3-BANK CENTER	25 LEFT SPINNER	33 RIGHT 3-BANK RIGHT	41 RIGHT SPECIAL ROLLOVER	49 PLAYFIELD TILT	57 NOT USED
2	WHT-RED 2 BALL ROLL TILT	10 LEFT SPECIAL ROLLOVER	18 LEFT 3-BANK TOP	26 "1" ROLLOVER	34 RIGHT 3-BANK SERIES	42 "S" ROLLOVER	50 4-BANK LEFT	58 NOT USED
3	WHT-ORN 3 CREDIT BUTTON	11 "W" ROLLOVER	19 LEFT 3-BANK SERIES	27 "2" ROLLOVER	35 RIGHT 3-BANK STANDUP	43 "R" ROLLOVER	51 4-BANK LEFT CENTER	59 NOT USED
4	WHT-YEL 4 RIGHT COIN SWITCH	12 "A" ROLLOVER	20 LEFT 3-BANK STANDUP	28 "3" ROLLOVER	36 TOP RIGHT STANDUP	44 RIGHT KICKER	52 4-BANK RIGHT CENTER	60 NOT USED
5	WHT-GRN 5 CENTER COIN SWITCH	13 LEFT KICKER	21 EJECT HOLE	29 "4" ROLLOVER	37 RIGHT SPINNER	45 TOP LEFT JET BUMPER	53 4-BANK RIGHT	61 NOT USED
6	WHT-BLU 6 LEFT COIN SWITCH	14 BOTTOM LEFT JET BUMPER	22 CAPTIVE BALL TARGET	30 MIDDLE RIGHT STANDUP	38 RIGHT BULL'S-EYE TARGET	46 TOP RIGHT JET BUMPER	54 4-BANK SERIES	62 NOT USED
7	WHT-VIO 7 SLAM TILT	15 NOT USED	23 LOWER TOP LEFT STANDUP	31 RIGHT 3-BANK LEFT	39 NOT USED	47 BOTTOM RIGHT JET BUMPER	55 NOT USED	63 NOT USED
8	WHT-GRY 8 HIGH SCORE RESET	16 LEFT 3-BANK BOTTOM	24 UPPER TOP LEFT STANDUP	32 RIGHT 3-BANK CENTER	40 TOP CENTER JET BUMPER	48 CENTER STANDUP	56 NOT USED	64 NOT USED

Figure 11. Switch Matrix

Table 15. Solenoids

SOL. NO.	FUNCTION	WIRE COLOR	CONNECTIONS	DRIVER TRANS.	COIL PART NO.
1	Ball Release	GRY-BRN	2P11-4, 8P3-17	Q15	SA-23-900-DC
2	Left 3-Bank Drop Targets Reset	GRY-RED	2P11-5, 8P3-18	Q17	SA3-23-900-DC
3	Eject Hole	GRY-ORN	2P11-7, 8P3-19	Q19	SG-23-900-DC
4	4-Bank Left Drop Targets Reset	GRY-YEL	2P11-8, 8P3-20	Q21	SA3-23-900-DC
5	4-Bank Right Drop Targets Reset	GRY-GRN	2P11-9, 8P3-21	Q23	SA3-23-900-DC
6	Right 3-Bank Drop Targets Reset	GRY-BLU	2P11-3, 8P3-22	Q25	SA3-23-900-DC
7	Bottom Right Jet Bumper	GRY-VIO	2P11-2, 8P3-23	Q27	SA3-23-900-DC
8	Flash Lamps	GRY-BLK	2P11-1, 8P3-24	Q29	Type 89 Bulbs
9	Sound	BRN-BLK	2P9-9, 7P1-11, 10P3-3	Q31	—
10	Sound	BRN-RED	2P9-7, 7P1-12, 10P3-2	Q33	—
11	Sound	BRN-ORN	2P9-1, 7P1-13, 10P3-5	Q35	—
12	Sound	BRN-YEL	2P9-2, 7P1-14, 10P3-4	Q37	—
13	Sound	BRN-GRN	2P9-3, JP1-15, 10P3-7	Q39	—
14	Credit Knocker	BRN-BLU	2P9-4, 7P1-16	Q41	SA2-23-900-DC
15	Not Used	BRN-VIO	2P9-5, 7P1-17	Q43	—
16	Coin Lockout	BRN-GRY	2P9-6, 7P1-18, 7P2-4	Q45	SM-35-9000-DC
17*	Bottom Left Jet Bumper	BLU-RED	2P12-4, 8P3-12	Q4	SG-23-900-DC
18*	Left Kicker	BLU-BRN	2P12-7, 8P3-11	Q2	SG-23-900-DC
19*	Top Left Jet Bumper	BLU-ORN	2P12-3, 8P3-13	Q6	SG-23-900-DC
20*	Top Right Jet Bumper	BLU-YEL	2P12-6, 8P3-14	Q8	SG-23-900-DC
21*	Top Center Jet	BLU-GRN	2P12-8, 8P3-15	Q10	SG-23-900-DC
22*	Right Kicker	BLU-BLK	2P12-9, 8P3-16	Q12	SG-23-900-DC
*	Right Flipper	BLU-VIO	7P1-8, 8P3-3	—	SFL-20-300/ 30-800-DC
*	Left Flipper	BLU-GRY	7P1-10, 8P3-4	—	SFL-20-300/ 30-800-DC

***NOTES:**

1. Special switch connections for solenoids 17 thru 22 are as follows:

- 17—ORN-RED—2P13-3, 8P3-6
- 18—ORN-BRN—2P13-5, 8P3-5
- 19—ORN-BLK—2P13-2, 8P3-7
- 20—ORN-YEL—2P13-4, 8P3-8
- 21—ORN-GRN—2P13-8, 8P3-9
- 22—ORN-BLK—2P13-9, 8P3-10

2. Flipper button connections are as follows:

- Right—ORN-VIO—2P12-1, 7P1-7
- Left—ORN-GRY—2P12-2, 7P1-9

3. Typical wiring for solenoids and special switches:

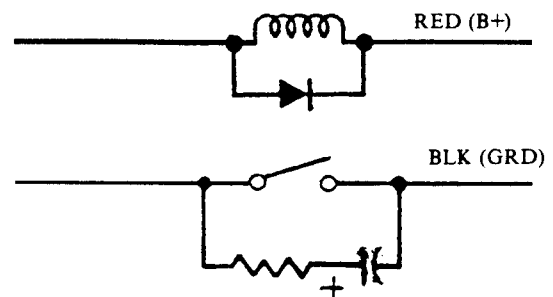

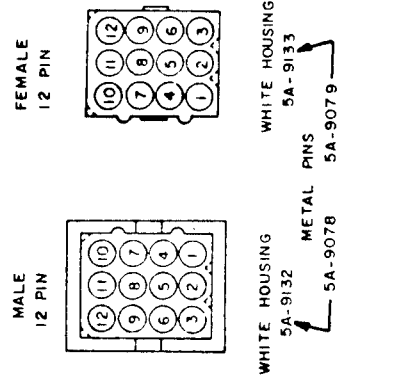
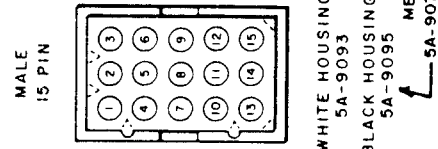
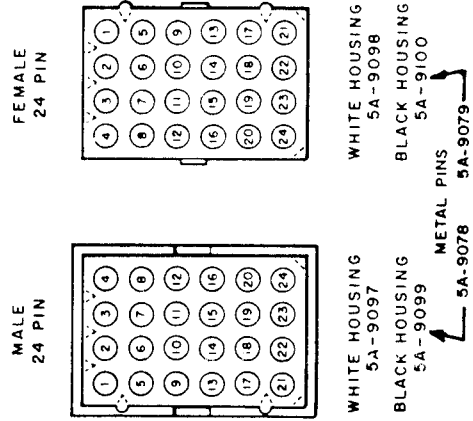
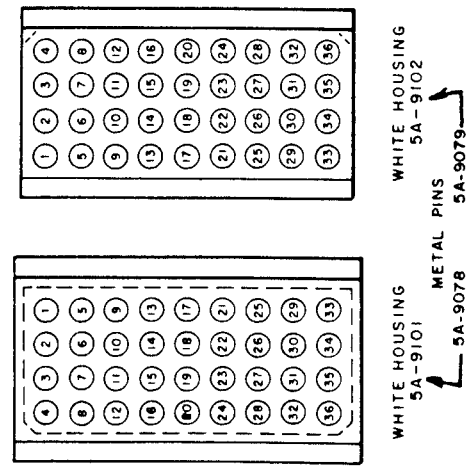
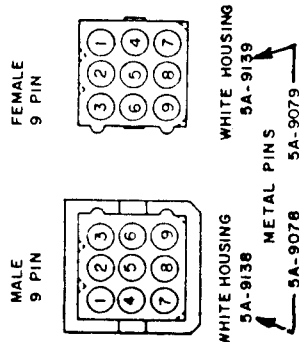
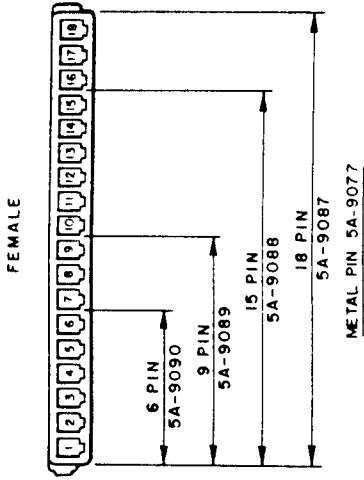
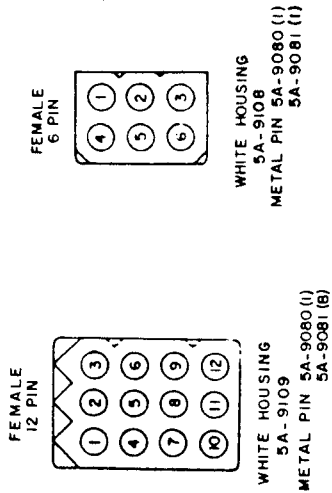
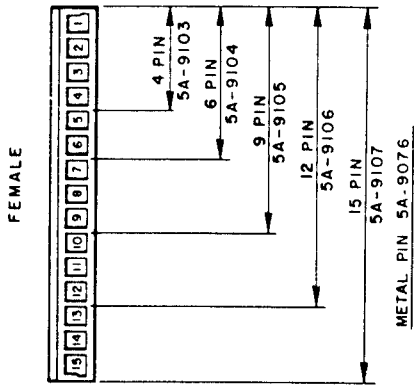
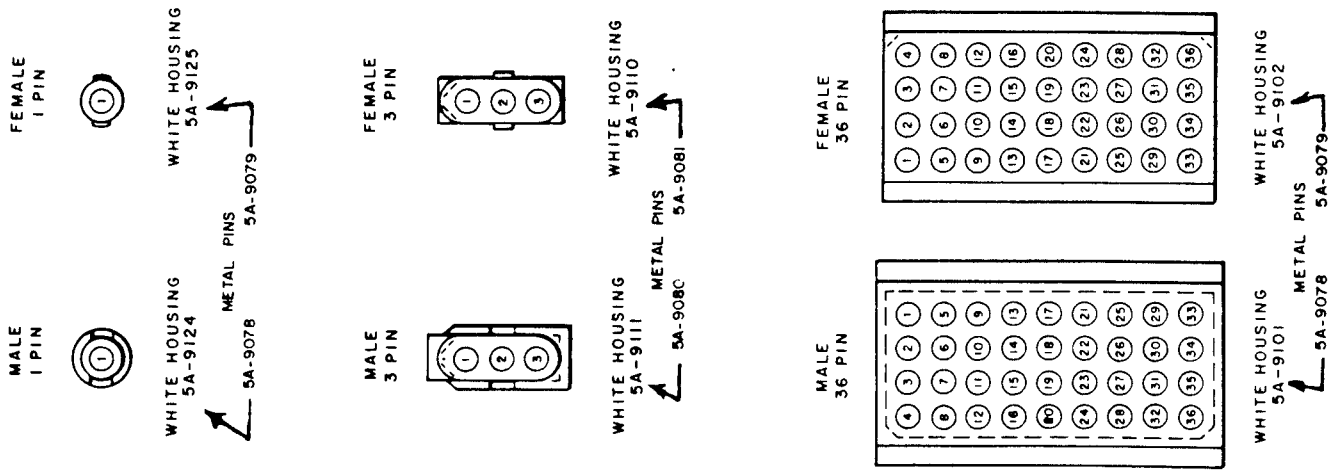

Figure 12. Connector Details

CPU BOARD

DRIVER BOARD

Pin	Wire Color	Function
1J1 - INTERBOARD CONNECTOR		
1P2 - LOGIC POWER BUS INPUT		
1	Black	Logic Ground
2	Black	Logic Ground
3	Black	Logic Ground
4	Gray	Logic B + (+5 VDC)
5	Gray	Logic B + (+5 VDC)
6	Gray	Logic B+ (+5 VDC)
7	Key	Key
8	N/C	Not Used
9	Gray-White	Logic B+ (+12 V Unregulated)

1P3 - DISPLAY BLANKING

1	N/C	Not Used
2	N/C	Not Used
3	Key	Key
4	Blue-White	Display Blanking

1P4 - DIAGNOSTIC SWITCH INPUTS

1	Key	Key
2	White	Diagnostic Common
3	Green	Diagnostic Advance
4	Blue	Diagnostic Auto/Man.

1P5 - MASTER DISPLAY BCD OUTPUTS

1	Blue-Yellow	Display BCD D1
2	Blue-Orange	Display BCD C1
3	Blue-Red	Display BCD B1
4	Blue-Brown	Display BCD A1
5	Blue-Gray	Display BCD D2
6	Key	Key
7	Blue-Violet	Display BCD C2
8	Blue-Black	Display BCD B2
9	Blue-Green	Display BCD A2

1P6 - MASTER DISPLAY STROBE OUTPUTS

1	Violet-Gray	Display Strobe #16
2	Violet-Black	Display Strobe #15
3	Violet-Blue	Display Strobe #14
4	Violet-Green	Display Strobe #13
5	Violet-Yellow	Display Strobe #12
6	Violet-Orange	Display Strobe #11
7	Key	Key
8	Violet-Red	Display Strobe #10
9	Violet-Brown	Display Strobe # 9

1P7 - MASTER DISPLAY STROBE OUTPUTS

1	Brown-Gray	Display Strobe # 8
2	Brown-Violet	Display Strobe # 7
3	Brown-Blue	Display Strobe # 6
4	Brown-Green	Display Strobe # 5
5	Brown-Yellow	Display Strobe # 4
6	Brown-Orange	Display Strobe # 3
7	Brown-Red	Display Strobe # 2
8	Key	Key
9	Brown-Black	Display Strobe # 1

Pin	Wire Color	Function
2P1 - INTERBOARD CONNECTOR		
2P2 - SWITCH COLUMN DRIVE		
*1	Green-Gray	Switch Column #8
2	Green-Violet	Switch Column #7
3	Green-Blue	Switch Column # 6
4	Key	Key
5	Green-Black	Switch Column # 5
6	Green-Yellow	Switch Column # 4
7	Green-Orange	Switch Column # 3
8	Green-Red	Switch Column # 2
9	Green-Brown	Switch Column # 1

2P3 - SWITCH ROW INPUTS

1	White-Gray	Switch Row # 8
2	Key	Key
3	White-Violet	Switch Row # 7
4	White-Blue	Switch Row # 6
5	White-Green	Switch Row # 5
6	White-Yellow	Switch Row # 4
7	White-Orange	Switch Row # 3
8	White-Red	Switch Row # 2
9	White-Brown	Switch Row # 1

2P4 - LAMP POWER BUS

1	Blue	Lamp B+
2	Blue	Lamp B+
3	Key	Key
4	Blue	Lamp B+
5	Blue	Lamp B+
6	N/C	Not Used
7	Blue	Lamp B+
8	Blue	Lamp B+
9	Blue	Lamp B+

2P5 - LAMP COLUMN DRIVE

1	Yellow-Violet	Lamp Column # 7
2	Yellow-Gray	Lamp Column # 8
3	Yellow-Green	Lamp Column # 5
4	Key	Key
5	Yellow-Blue	Lamp Column # 6
6	Yellow-Orange	Lamp Column # 3
7	Yellow-Black	Lamp Column # 4
8	Yellow-Brown	Lamp Column # 1
9	Yellow-Red	Lamp Column # 2

2P6 - LAMP GROUNDS

1	Black	Lamp Ground
2	Key	Key
3	Black	Lamp Ground
4	Black	Lamp Ground
5	N/C	Not Used
6	Black	Lamp Ground
7	Black	Lamp Ground
8	Black	Lamp Ground
9	Black	Lamp Ground

*Switch column 8 is not used.

DRIVER BOARD (con't)

Pin	Wire Color	Function
2P7 - LAMP ROW DRIVE		
1	Red-Brown	Lamp Row # 1
2	Red-Black	Lamp Row # 2
3	Red-Orange	Lamp Row # 3
4	Red-Yellow	Lamp Row # 4
5	Red-Green	Lamp Row # 5
6	Red-Blue	Lamp Row # 6
7	Key	Key
8	Red-Gray	Lamp Row # 8
9	Red-Violet	Lamp Row # 7

2P8 - LOGIC POWER BUS INPUT

1	Black	Logic Ground
2	Black	Logic Ground
3	Black	Logic Ground
4	Black	Logic Ground
5	Key	Key
6	Gray	Logic B+ (+5 VDC)
7	Gray	Logic B+ (+5 VDC)
8	Gray	Logic B+ (+5 VDC)
9	Gray	Logic B+ (+5 VDC)

***2P9 - CABINET SOLENOIDS DRIVE**

1	Brown-Orange	Solenoid 11 Sound
2	Green-Violet	Solenoid 12 Sound
3	Brown-Green	Solenoid 13 Sound
4	Brown-Blue	Solenoid 14 Credit Knocker
5	Brown-Violet	Solenoid 15
6	Brown-Gray	Solenoid 16, Coin Lockout
7	Brown-Red	Solenoid 10 Sound
8	Key	Key
9	Brown-Black	Solenoid 9 Sound

2P10 - SOLENOID GROUNDS

1	Black	Solenoid Ground
2	Black	Solenoid Ground
3	Black	Solenoid Ground
4	Black	Solenoid Ground
5	Key	Key
6	N/C	Not Used
7	Black	Solenoid Ground
8	Black	Solenoid Ground
9	Black	Solenoid Ground

***2P11 - PLAYFIELD SOLENOIDS DRIVE**

1	Gray-Black	Solenoid 8
2	Gray-Violet	Solenoid 7
3	Gray-Blue	Solenoid 6
4	Gray-Brown	Solenoid 1
5	Gray-Red	Solenoid 2
6	Key	Key
7	Gray-Orange	Solenoid 3
8	Gray-Yellow	Solenoid 4
9	Gray-Green	Solenoid 5

DRIVER BOARD (con't)

Pin	Wire Color	Function
*2P12 - SPECIAL SOLENOIDS DRIVE		
1	Orange-Violet	Right Flipper Enable
2	Orange-Gray	Left Flipper Enable
3	Blue-Orange	Solenoid 19 (Special Solenoid 3)
4	Blue-Red	Solenoid 17 (Special Solenoid 2)
5	Key	Key
6	Blue-Yellow	Solenoid 20 (Special Solenoid 4)
7	Blue-Brown	Solenoid 18 (Special Solenoid 1)
8	Blue-Green	Solenoid 21 (Special Solenoid 5)
9	Blue-Black	Solenoid 22 (Special Solenoid 6)

***2P13 - SPECIAL SWITCH INPUTS**

1	Key	Key
2	Orange-Black	Special Switch 3
3	Orange-Red	Special Switch 2
4	Orange-Yellow	Special Switch 4
5	Orange-Brown	Special Switch 1
6	N/C	Not Used
7	N/C	Not Used
8	Orange-Green	Special Switch 5
9	Orange-Blue	Special Switch 6

POWER SUPPLY**3P1 - POWER BUS INPUTS**

1	Violet	Lamps (+18 VDC)
2	Orange	Solenoids (+28 VDC)
3	N/C	Not Used
4	White	90 VAC
5	N/C	Not Used
6	N/C	Not Used
7	N/C	Not Used
8	N/C	Not Used
9	White	90 VAC
10	Gray	18.7 VAC
11	Gray	18.7 VAC
12	Gray-White	18.7 VAC C.T.

3P2 - POWER BUS INPUTS

1	N/C	Not Used
2	N/C	Not Used
3	Black	Solenoid Rect.
4	N/C	Not Used
5	N/C	Not Used
6	Black	Lamp Rect.

3P3 - SOLENOID POWER BUS

1	N/C	Not Used
2	N/C	Not Used
3	Black	Ground
4	N/C	Not Used
5	N/C	Not Used
6	Red	Solenoid B+ (+28 VDC)
7	Red	Solenoid B+ (+28 VDC)
8	N/C	Not Used
9	Key	Key

*Refer to Table 15 for solenoid assignments.

POWER SUPPLY (Con't.)

MASTER DISPLAY

Pin	Wire Color	Function
3P4 - LAMP & SOLENOID POWER BUS		
1	Black	Ground
2	Black	Ground
3	Black	Ground
4	Black	Ground
5	Blue	Lamp B+ (+16 VDC)
6	Blue	Lamp B+ (+16 VDC)
7	Blue	Lamp B+ (+16 VDC)
8	Blue	Lamp B+ (+16 VDC)
9	Black	Ground
10	Black	Ground
11	Black	Ground
12	Black	Ground

3P5 - DISPLAY POWER BUS

1	Black	Ground
2	N/C	Not Used
3	Orange & Wht-Blk	-100 VDC
4	Brown	+100 VDC
5	Key	Key
6	Gray	Logic B+ (+5 VDC)

3P6 - LOGIC POWER BUS

1	N/C	Not Used
2	N/C	Not Used
3	N/C	Not Used
4	N/C	Not Used
5	Key	Key
6	Gray-White	Logic B+ (+12 V Un-regulated)
7	Gray	Logic B+ (+5 VDC)
8	Gray	Logic B+ (+5 VDC)
9	Gray	Logic B+ (+5 VDC)
10	Gray	Logic B+ (+5 VDC)
11	Black	Ground
12	Black	Ground
13	Black	Ground
14	Black	Ground
15	Black	Ground

MASTER DISPLAY**4P1 - MASTER DISPLAY PLAYER #1**

1	Brown-Black	Units
2	Brown-Red	10's
3	Brown-Orange	100's
4	Brown-Yellow	1,000's
5	Brown-Green	10,000's
6	N/C	Key
7	Brown-Blue	100,000's
8	Brown	a)
9	Red	b)
10	Blue	f)
11	Violet	g)
12	Orange	c)
13	Green	e)
14	Yellow	d)
15	White-Black	Cathode Keep Alive

Pin Wire Color Function**4P2 - MASTER DISPLAY PLAYER #2**

1	White-Black	Cathode Keep Alive
2	Red-Black	Units
3	Red-Brown	10's
4	Red-Orange	100's
5	Red-Yellow	1000's
6	Yellow	d)
7	Green	e)
8	Orange	c)
9	N/C	Key
10	Violet	g)
11	Blue	f)
12	Red	b)
13	Brown	a)
14	Red-Green	10,000's
15	Red-Blue	100,000's

4P3 - MASTER DISPLAY PLAYER #3

1	White-Black	Cathode Keep Alive
2	Orange-Yellow	100's
3	Orange-Green	1000's
4	N/C	Key
5	Orange-Blue	10,000's
6	Orange-Violet	100,000's
8	Orange-Brown	Units
9	Brown	a)
10	Red	b)
11	Blue	f)
12	Violet	g)
13	Orange	c)
14	Green	e)
15	Yellow	d)

4P4 - MASTER DISPLAY #4

1	Yellow	d)
2	Green	e)
3	Orange	c)
4	Violet	g)
5	Blue	f)
6	Red	b)
7	Brown	a)
8	Yellow-Brown	Units
9	Yellow-Red	10's
10	Yellow-Orange	100's
11	N/C	Key
12	Yellow-Green	1000's
13	Yellow-Blue	10,000's
14	Yellow-Violet	100,000's
15	White-Black	Cathode Keep Alive

MASTER DISPLAY**4P5 - MASTER DISPLAY STROBE INPUTS**

Pin	Wire Color	Function
1	N/C	Not Used
2	Brown-Gray	Strobe# 8
3	Brown-Violet	Strobe# 7
4	Violet-Gray	Strobe#16
5	Violet-Black	Strobe#15
6	Brown-Black	Strobe# 1
7	Brown-Red	Strobe# 2
8	Brown-Orange	Strobe# 3
9	Brown-Yellow	Strobe# 4
10	Brown-Green	Strobe# 5
11	Brown-Blue	Strobe# 6
12	Violet-Red	Strobe#10
13	Violet-Orange	Strobe#11
14	Violet-Blue	Strobe#14
15	Violet-Brown	Strobe# 9
16	Violet-Green	Strobe#13
17	Violet-Yellow	Strobe#12
18	N/C	Not Used

4P6 - MASTER DISPLAY BCD INPUTS

1	Blue-Red	B1
2	Blue-Orange	C1
3	Blue-White	Blanking
4	Blue-Yellow	D1
5	Blue-Brown	A1
6	Blue-Black	B2
7	Blue-Violet	C2
8	Blue-Gray	D2
9	Blue-Green	A2

4P7 - MASTER DISPLAY POWER INPUTS

1	White-Black	Keep Alive -100 VDC
2	Brown	+100 VDC
3	Gray	Logic B+ (+5 VDC)
4	N/C	Not Used
5	Black	Ground
6	Orange	-100 VDC

PLAYER DISPLAYS**5P1 - PLAYER #1 SLAVE DISPLAY**

1	Blue	f
2	Violet	g
3	Brown-Blue	100,000's
4	Green	e
5	Yellow	d
6	Brown-Green	10,000's
7	Brown-Yellow	1,000's
8	N/C	Not Used
9	Brown-White	Anode Keep Alive
10	White-Black	Cathode Keep Alive
11	Brown-Orange	100's
12	Brown-Red	10's
13	N/C	Key
14	Orange	c
15	Brown-Black	Units
16	Red	b
17	Brown	a
18	N/C	Not Used

PLAYER DISPLAYS (con't)**5P2 - PLAYER #2 SLAVE DISPLAY**

1	Blue	f
2	Violet	g
3	Red-Blue	100,000's
4	Green	e
5	Yellow	d
6	Red-Green	10,000's
7	Red-Yellow	1,000's
8	N/C	Not Used
9	Brown-White	Anode Keep Alive
10	White-Black	Cathode Keep Alive
11	Red-Orange	100's
12	Red-Brown	10's
13	N/C	Key
14	Orange	c
15	Red-Black	Units
16	Red	b
17	Brown	a
18	N/C	Not Used

5P3 - PLAYER #3 SLAVE DISPLAY

1	Blue	f
2	Violet	g
3	Orange-Violet	100,000's
4	Green	e
5	Yellow	d
6	Orange-Blue	10,000's
7	Orange-Green	1,000's
8	N/C	Not Used
9	Brown-White	Anode Keep Alive
10	White-Black	Cathode Keep Alive
11	Orange-Yellow	100's
12	Orange-Red	10's
13	N/C	Key
14	Orange	c
15	Orange-Brown	Units
16	Red	b
17	Brown	a
18	N/C	Not Used

5P4 - PLAYER #4 SLAVE DISPLAY

1	Blue	f
2	Violet	g
3	Yellow-Violet	100,000's
4	Green	e
5	Yellow	d
6	Yellow-Blue	10,000's
7	Yellow-Green	1,000's
8	N/C	Not Used
9	Brown-White	Anode Keep Alive
10	White-Black	Cathode Keep Alive
11	Yellow-Orange	100's
12	Yellow-Red	10's
13	N/C	Key
14	Orange	c
15	Yellow-Brown	Units
16	Red	b
17	Brown	a
18	N/C	Not Used

BACK BOX MISCELLANEOUS

Pin	Color	Function
6P1/6J1 - SWITCHED AC INPUT		
1	White-Red	AC
2	N/C	
3	White-Red	AC
6P2/6J2 - FLIPPER POWER		
1	White-Red	Flipper B+
6P3/6J3 - SOUND BOARD POWER		
1	Gray	18.7 VAC
2-4	N/C	Not Used
5	Gray-White	18.7 VAC C. T.
6-8	N/C	Not Used
9	Gray	18.7 VAC

CABINET

7P1/7J1 - CABINET SOLENOIDS & SWITCHES
(White 36 Pin)

1	Yellow	6.3 VAC Display Lamps
2	Yellow-White	6.3 VAC Display Lamps
3	Red	Solenoid B+
4	White	Diagnostic Common
5	Green	Diagnostic Advance
6	Blue	Diagnostic Auto-Man.
7	Orange-Violet	Right Flipper Enable
8	Blue-Violet	Right Flipper Switch
9	Orange-Gray	Left Flipper Enable
10	Blue-Gray	Left Flipper Switch
11	Brown-Black	Solenoid 9 Sound
12	Brown-Red	Solenoid 10 Sound
13	Brown-Orange	Solenoid 11 Sound
14	Brown-Yellow	Solenoid 12 Sound
15	Brown-Green	Solenoid 13 Sound
16	Brown-Blue	Solenoid 14 (Knocker)
17	Brown-Violet	Solenoid 15 (Not Used)
18	Brown-Gray	Solenoid 16 (Coin Lockout)
19	Green-Brown	Switch Column # 1
20	N/C	Not Used
21	White-Brown	Switch Row # 1
22	White-Red	Switch Row # 2
23	White-Orange	Switch Row # 3
24	White-Yellow	Switch Row # 4
25	White-Green	Switch Row # 5
26	White-Blue	Switch Row # 6
27	White-Violet	Switch Row # 7
28	White-Gray	Switch Row # 8
29-36	N/C	Not Used

CABINET (con't)

Pin	Color	Function
7P2/7J2 - COIN DOOR (White-15 Pin)		
1	Yellow	6.3 VAC Display Lamps
2	Yellow-White	6.3 VAC Display Lamps
3	Red	Coil B+
4	Brown-Gray	Solenoid 16 (Coin Lockout)
5	N/C	Not Used
6	Green-Brown	Switch Column # 1
7	N/C	Not Used
8	White-Yellow	Switch Row # 4
9	White-Green	Switch Row # 5
10	White-Blue	Switch Row # 6
11	White-Violet	Switch Row # 7
12	White-Gray	Switch Row # 8
13	White	Diagnostic Common
14	Green	Advance
15	Blue	Auto/Manual

PLAYFIELD

8P1/8J1 - PLAYFIELD SWITCHES (White-15 Pin)

1	Green-Red	Switch Column # 2
2	Green-Orange	Switch Column # 3
3	Green-Yellow	Switch Column # 4
4	Green-Black	Switch Column # 5
5	Green-Blue	Switch Column # 6
6	Green-Violet	Switch Column # 7
*7	Green-Gray	Switch Column # 8
8	White-Brown	Switch Row # 1
9	White-Red	Switch Row # 2
10	White-Orange	Switch Row # 3
11	White-Yellow	Switch Row # 4
12	White-Green	Switch Row # 5
13	White-Blue	Switch Row # 6
14	White-Violet	Switch Row # 7
15	White-Gray	Switch Row # 8

*Switch Column 8 is not used.

PLAYFIELD (con't)

Pin	Wire Color	Function
8P2/8J2 - PLAYFIELD LAMPS (White-24 Pin)		
1	Yellow	6.3 VAC Display
2	Yellow-White	6.3 VAC Display
3	Yellow-Brown	Lamp Column # 1
4	Yellow-Red	Lamp Column # 2
5	Yellow-Orange	Lamp Column # 3
6	Yellow-Black	Lamp Column # 4
7	Yellow-Green	Lamp Column # 5
8	Yellow-Blue	Lamp Column # 6
9	Yellow-Violet	Lamp Column # 7
10	N/C	Not Used
11	Red-Brown	Lamp Row # 1
12	Red-Black	Lamp Row # 2
13	Red-Orange	Lamp Row # 3
14	Red-Yellow	Lamp Row # 4
15	Red-Green	Lamp Row # 5
16	Red-Blue	Lamp Row # 6
17	Red-Violet	Lamp Row # 7
18	Red-Gray	Lamp Row # 8
19-24	N/C	Not Used

***8P3/8J3 - PLAYFIELD SOLENOIDS, SPECIAL SWITCHES (Black) (24 Pin)**

1	Red	Coil B+
2	Black	Ground (Special Switch Common)
3	Blue-Violet	Right Flipper Coil
4	Blue-Gray	Left Flipper Coil
5	Orange-Brown	Special Switch 1
6	Orange-Red	Special Switch 2
7	Orange-Black	Special Switch 3
8	Orange-Yellow	Special Switch 4
9	Orange-Green	Special Switch 5
10	Orange-Blue	Special Switch 6
11	Blue-Brown	Solenoid 18 (Special Sol. 1)
12	Blue-Red	Solenoid 17 (Special Sol. 2)
13	Blue-Orange	Solenoid 19 (Special Sol. 3)
14	Blue-Yellow	Solenoid 20 (Special Sol. 4)
15	Blue-Green	Solenoid 21 (Special Sol. 5)
16	N/C	Solenoid 22 (Special Sol. 6)
17	Gray-Brown	Solenoid 1
18	Gray-Red	Solenoid 2
19	Gray-Orange	Solenoid 3
20	Gray-Yellow	Solenoid 4
21	Gray-Green	Solenoid 5
22	Gray-Blue	Solenoid 6
23	Gray-Violet	Solenoid 7
24	Gray-Black	Solenoid 8

INSERT BOX

Pin	Color	Function
9P1/9J1 - INSERT DOOR LAMP CONNECTOR (Black-15 Pin)		
1	Yellow	6.3 VAC Display Lamps
2	Yellow-White	6.3 VAC Display Lamps
3	N/C	Not Used
4	Yellow	6.3 VAC Display Lamps
5	Yellow-White	6.3 VAC Display Lamps
6	Yellow-Violet	Lamp Column # 7
7	Yellow-Gray	Lamp Column # 8
8	Red-Brown	Lamp Row # 1
9	Red-Black	Lamp Row # 2
10	Red-Orange	Lamp Row # 3
11	Red-Yellow	Lamp Row # 4
12	Red-Green	Lamp Row # 5
13	Red-Blue	Lamp Row # 6
14	Red-Violet	Lamp Row # 7
15	Red-Gray	Lamp Row # 8

9P2/9J2 - PLAYER 1 KEEP ALIVE

1	Brown-White	Anode Keep Alive
---	-------------	------------------

9P3/9J3 - PLAYER 2 KEEP ALIVE

1	Brown-White	Anode Keep Alive
---	-------------	------------------

9P4/9J4 - PLAYER 3 KEEP ALIVE

1	Brown-White	Anode Keep Alive
---	-------------	------------------

9P5/9J5 - PLAYER 4 KEEP ALIVE

1	Brown-White	Anode Keep Alive
---	-------------	------------------

SOUND BOARD**10P1/10J1 - POWER INPUTS**

1	Gray	18.7 VAC
2-4	N/C	Not Used
5	Gray-White	18.7 VAC C.T.
6	N/C	Not Used
7	Key	Key
8	N/C	Not Used
9	Gray	18.7 VAC

10P2/10J2 - SPEAKER OUTPUT

1	N/C	Not Used
2	Red	Speaker +
3	Black	Speaker Com
4	N/C	Not Used

10P3/10J3 - SOUND SELECT INPUTS

1	Key	Key
2	Brown-Red	Sound (10)
3	Brown-Black	Sound (9)
4	Brown-Yellow	Sound (12)
5	Brown-Orange	Sound (11)
6	N/C	Not Used
7	Brown-Green	Sound (13)
8	N/C	Not Used
9	N/C	Not Used

SECTION 8 MECHANICAL ADJUSTMENTS

SWITCHES

There are different types of switches used throughout the game. The switch blades are made of a highly conductive spring type metal in various lengths, thickness, and form. Each switch is designed to satisfy specific operation conditions such as bounce, current carrying capacity, speed of operation, etc. Therefore, it is important to replace a blade with one of the same kind. When adjusting blades, never kink or bend sharply, as this causes fatigue which leads to fractures. Adjust blades with a sweeping, bowing motion, with a switch adjusting tool or duck bill pliers.

When switch adjustments are called for, before forming blades on any machine, check that the screws holding the switch stacks are down very tight. This is recommended because plastic spacers in the switch stacks will occasionally shrink by drying out causing a poor adjustment.

With few exceptions, all blade type switches should have at least $1/32$ inch between the contact points and should follow thru for at least $1/32$ inch beyond the point at which the contacts close. This follow thru action provides a wiping motion between the contacts keeping them clean and insuring good contact between the points.

To adjust blade type switches properly, first adjust the actuating blade (usually, the longer one) with relation to the part that it contacts. Then set the gap and follow thru by adjusting the other blade.

SWITCH CONTACTS

With the exception of flipper button and end of stroke switches, all blade switch contacts are gold-plated and must NOT be burnished or filed. To clean the contacts, close them on a clean piece of paper (e.g. business card) and wipe gently until the contacts are clean. For the flipper button switches, remove tarnish by filing with a contact file and then burnishing. Do the same for the flipper end-of-stroke switch contacts.

Severely pitted contacts should be replaced as an assembly. Switch contacts should only be adjusted when they cause a malfunction or do not score properly.

ROLL-OVER LANE SWITCHES

Playfield lane switches are operated by a wire form or button which is actuated by the ball. Before the switch is adjusted, the wire should be centered in the playfield slot. The long blade closest to the playfield should be adjusted to hold the roll-over up. Check this condition with the playfield down. Then, with the playfield up, adjust the short blade for $1/16$ inch clearance. Depress the roll-over to its maximum depression with the ball and check for $1/32$ inch follow thru. To prevent switch vibration a back-up blade is used. It should be parallel and just barely in contact with the short blade.

FLIPPER

Flippers are controlled by the flipper pushbuttons at each side of the cabinet. Each coil consists of two windings: A pull-in winding and a lighter gauge hold-in winding. The hold-in winding is normally bypassed by a closed switch.

The pull-in winding produces a strong stroke. However, if this winding were to remain energized by the player it would overheat. To reduce this high current, the hold winding is put in series with the pull-in winding by opening the end-of-stroke switch.

This switch should be adjusted so that the long blade is moved by the flipper pawl assembly for about the last $1/8$ inch of movement. With the plunger completely depressed manually, both switches should be adjusted for a $3/32$ inch gap. The short blade should have a $1/32$ inch follow thru.

NEVER LUBRICATE THE PLUNGER. The only lubrication required is the link assembly with the special coin machine lubricant.

Weak or sluggish flipper action can be due to dirty or improperly adjusted contact points, worn out coil sleeve, loose or broken bushing, incorrect coil or shorted diodes, worn out fiber links, weak or broken return spring, loose coil between the retaining bracket and coil stop, or loose screws. Check all of the above to correct.

TILT SWITCHES

The plumb bob tilt can be made more sensitive by raising the plumb bob on the shaft and less sensitive lowering the bob on the shaft. The super slam tilt on the coin door is adjustable. The normal adjustment is contacts open $1/32$ inch. The playfield tilt is adjustable by forming the switch contacts. Closing the gap will make the tilt more sensitive. The ball roll tilt in the cabinet box can be raised (more sensitive) or lowered (less sensitive) at the front pivot slot.

SECTION 9 SPARE PARTS

The parts used on the solid state STELLAR WARS are standard Williams parts. Refer to Figure 13 for identification of various playfield parts and adjustments.

PLAYFIELD CARE

The playfield on this machine has an improved finish with excellent wearing properties. **DO NOT** clean the board with water, water soap solutions, or harsh abrasives. Avoid using steel wool, kitchen cleansers, or abrasive hand soap. Water will weaken the adhering of the paint to the board and abrasives shorten the board life.

A wax base cleaner with negligible abrasive qualities used lightly, but frequently, will extend board life.

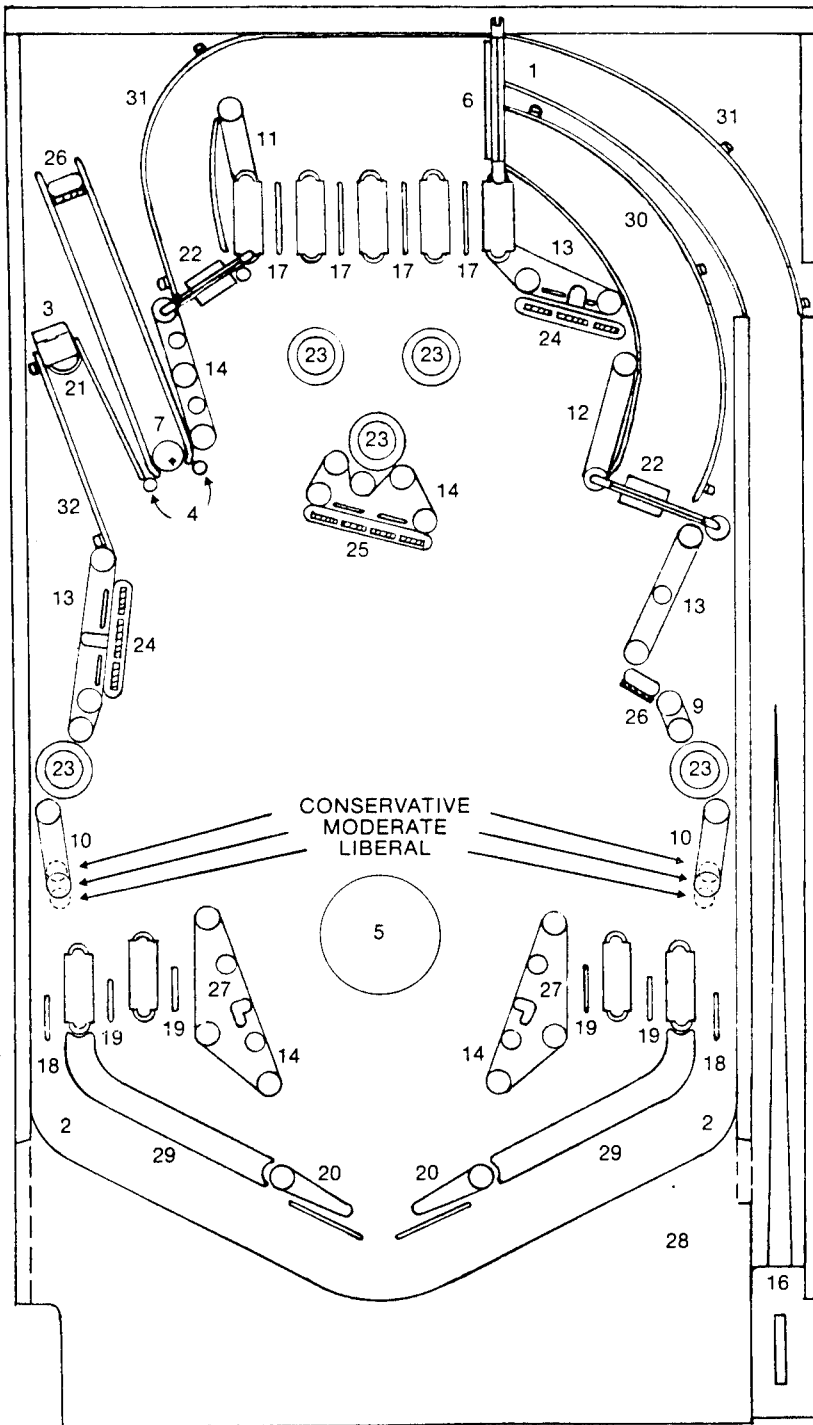

PLAYFIELD PARTS

Item	Part No.	Description
1.	1A-3206-5	MOUNTING BRACKET FOR BALLGATE WIRE
2.	1B-3417-11	CHROME BALL GUIDE—LEFT OR RIGHT
3.	1A-6793	STOP BRACKET FOR BALL EJECTOR HOLE
4.	2A-4008	POST FOR RUBBER BUMPER (2 USED)
5.	3B-7545	PLEXIGLASS INSERT 5" DIA.
6.	12A-6532	BALLGATE WIRE
7.	20A-6500	CAPTIVE BALL 1-1/16 DIA.
8.	23A-6300	RUBBER RING 5/16" ID (17 USED)
9.	23A-6301	RUBBER RING 3/4" ID
10.	23A-6303	RUBBER RING 1-1/4" ID
11.	23A-6304	RUBBER RING 1-1/2" ID
12.	23A-6305	RUBBER RING 2" ID
13.	23A-6306	RUBBER RING 2-3/8" ID
14.	23A-6307	RUBBER RING 2-7/8" ID
15.	30C-490	SET OF 10 PLAYFIELD PLASTIC
16.	30B-3573-1	BALL SHOOTER GAUGE PLATE
17.	A-5844-8	ROLLOVER WIRE ASSY (4 USED)
18.	A-5844-9	ROLLOVER WIRE ASSY (2 USED)
19.	A-5844-34	ROLLOVER WIRE ASSY (4 USED)
20.	B-7060	FLIPPER ASSY
21.	B-7472-5R	BALL EJECTOR ASSY
22.	B-7875-490	SPINNING TARGET ASSY
23.	B-7894	JET BUMPER ASSY
24.	D-7931-3S	DROP TARGET ASSY (TRIPLE BANK)
25.	D-7931-4S	DROP TARGET ASSY (FOUR BANK)
26.	A-8054	STATIONARY TARGET ASSY (2 USED)
27.	B-8055	BALL KICKER ASSY
28.	D-8088	BOTTOM ARCH ASSY
29.	B-8144	FLIPPER RETURN FRAME (LEFT OR RIGHT)
30.	C-8157	UPPER RIGHT BALLRAIL ASSY
31.	C-8158	TOP BALLRAIL ASSY
32.	A-8159	UPPER LEFT BALLRAIL ASSY

POST ADJUSTMENTS

To make game more conservative or liberal, move post 3/16" as shown in sketch. Spotting holes are provided and can be seen upon removal of posts.

Figure 13. Playfield Spare Parts